



ANSI/TIA-606-B-2012  
APPROVED: JUNE 22, 2012

# TIA STANDARD

## Administration Standard for Telecommunications Infrastructure

TIA-606-B  
(Revision of TIA-606-A)

June 2012

TELECOMMUNICATIONS  
INDUSTRY ASSOCIATION

[tiaonline.org](http://tiaonline.org)

## NOTICE

TIA Engineering Standards and Publications are designed to serve the public interest through eliminating misunderstandings between manufacturers and purchasers, facilitating interchangeability and improvement of products, and assisting the purchaser in selecting and obtaining with minimum delay the proper product for their particular need. The existence of such Standards and Publications shall not in any respect preclude any member or non-member of TIA from manufacturing or selling products not conforming to such Standards and Publications. Neither shall the existence of such Standards and Publications preclude their voluntary use by Non-TIA members, either domestically or internationally.

Standards and Publications are adopted by TIA in accordance with the American National Standards Institute (ANSI) patent policy. By such action, TIA does not assume any liability to any patent owner, nor does it assume any obligation whatever to parties adopting the Standard or Publication.

This Standard does not purport to address all safety problems associated with its use or all applicable regulatory requirements. It is the responsibility of the user of this Standard to establish appropriate safety and health practices and to determine the applicability of regulatory limitations before its use.

(From Project No. ANSI/TIA-PN-606-B, formulated under the cognizance of the TIA TR-42 Telecommunications Cabling Systems, TR-42.6 Subcommittee on Telecommunications Infrastructure and Equipment Administration (606).

Published by  
©TELECOMMUNICATIONS INDUSTRY ASSOCIATION  
Standards and Technology Department  
2500 Wilson Boulevard  
Arlington, VA 22201 U.S.A.

**PRICE: Please refer to current Catalog of  
TIA TELECOMMUNICATIONS INDUSTRY ASSOCIATION STANDARDS  
AND ENGINEERING PUBLICATIONS  
or call IHS, USA and Canada  
(1-877-413-5187) International (303-397-2896)  
or search online at <http://www.tiaonline.org/standards/catalog/>**

All rights reserved  
Printed in U.S.A.

# NOTICE OF COPYRIGHT

**This document is copyrighted by the TIA.**

**Reproduction of these documents either in hard copy or soft copy (including posting on the web) is prohibited without copyright permission.** For copyright permission to reproduce portions of this document, please contact the TIA Standards Department or go to the TIA website ([www.tiaonline.org](http://www.tiaonline.org)) for details on how to request permission. Details are located at:

<http://www.tiaonline.org/standards/catalog/info.cfm#copyright>

or

Telecommunications Industry Association  
Technology & Standards Department  
2500 Wilson Boulevard, Suite 300  
Arlington, VA 22201 USA  
+1.703.907.7700

Organizations may obtain permission to reproduce a limited number of copies by entering into a license agreement. For information, contact

IHS  
15 Inverness Way East  
Englewood, CO 80112-5704  
or call  
USA and Canada (1.800.525.7052)  
International (303.790.0600)



## **NOTICE OF DISCLAIMER AND LIMITATION OF LIABILITY**

The document to which this Notice is affixed (the "Document") has been prepared by one or more Engineering Committees or Formulating Groups of the Telecommunications Industry Association ("TIA"). TIA is not the author of the Document contents, but publishes and claims copyright to the Document pursuant to licenses and permission granted by the authors of the contents.

TIA Engineering Committees and Formulating Groups are expected to conduct their affairs in accordance with the TIA Engineering Manual ("Manual"), the current and predecessor versions of which are available at <http://www.tiaonline.org/standards/procedures/manuals>/TIA's function is to administer the process, but not the content, of document preparation in accordance with the Manual and, when appropriate, the policies and procedures of the American National Standards Institute ("ANSI"). TIA does not evaluate, test, verify or investigate the information, accuracy, soundness, or credibility of the contents of the Document. In publishing the Document, TIA disclaims any undertaking to perform any duty owed to or for anyone.

If the Document is identified or marked as a project number (PN) document, or as a standards proposal (SP) document, persons or parties reading or in any way interested in the Document are cautioned that: (a) the Document is a proposal; (b) there is no assurance that the Document will be approved by any Committee of TIA or any other body in its present or any other form; (c) the Document may be amended, modified or changed in the standards development or any editing process.

The use or practice of contents of this Document may involve the use of intellectual property rights ("IPR"), including pending or issued patents, or copyrights, owned by one or more parties. TIA makes no search or investigation for IPR. When IPR consisting of patents and published pending patent applications are claimed and called to TIA's attention, a statement from the holder thereof is requested, all in accordance with the Manual. TIA takes no position with reference to, and disclaims any obligation to investigate or inquire into, the scope or validity of any claims of IPR. TIA will neither be a party to discussions of any licensing terms or conditions, which are instead left to the parties involved, nor will TIA opine or judge whether proposed licensing terms or conditions are reasonable or non-discriminatory. TIA does not warrant or represent that procedures or practices suggested or provided in the Manual have been complied with as respects the Document or its contents.

If the Document contains one or more Normative References to a document published by another organization ("other SSO") engaged in the formulation, development or publication of standards (whether designated as a standard, specification, recommendation or otherwise), whether such reference consists of mandatory, alternate or optional elements (as defined in the TIA Engineering Manual, 4<sup>th</sup> edition) then (i) TIA disclaims any duty or obligation to search or investigate the records of any other SSO for IPR or letters of assurance relating to any such Normative Reference; (ii) TIA's policy of encouragement of voluntary disclosure (see Engineering Manual Section 6.5.1) of Essential Patent(s) and published pending patent applications shall apply; and (iii) Information as to claims of IPR in the records or publications of the other SSO shall not constitute identification to TIA of a claim of Essential Patent(s) or published pending patent applications.

TIA does not enforce or monitor compliance with the contents of the Document. TIA does not certify, inspect, test or otherwise investigate products, designs or services or any claims of compliance with the contents of the Document.

ALL WARRANTIES, EXPRESS OR IMPLIED, ARE DISCLAIMED, INCLUDING WITHOUT LIMITATION, ANY AND ALL WARRANTIES CONCERNING THE ACCURACY OF THE CONTENTS, ITS FITNESS OR APPROPRIATENESS FOR A PARTICULAR PURPOSE OR USE, ITS MERCHANTABILITY AND ITS NONINFRINGEMENT OF ANY THIRD PARTY'S INTELLECTUAL PROPERTY RIGHTS. TIA EXPRESSLY DISCLAIMS ANY AND ALL RESPONSIBILITIES FOR THE ACCURACY OF THE CONTENTS AND MAKES NO REPRESENTATIONS OR WARRANTIES REGARDING THE CONTENT'S COMPLIANCE WITH ANY APPLICABLE STATUTE, RULE OR REGULATION, OR THE SAFETY OR HEALTH EFFECTS OF THE CONTENTS OR ANY PRODUCT OR SERVICE REFERRED TO IN THE DOCUMENT OR PRODUCED OR RENDERED TO COMPLY WITH THE CONTENTS.

TIA SHALL NOT BE LIABLE FOR ANY AND ALL DAMAGES, DIRECT OR INDIRECT, ARISING FROM OR RELATING TO ANY USE OF THE CONTENTS CONTAINED HEREIN, INCLUDING WITHOUT LIMITATION ANY AND ALL INDIRECT, SPECIAL, INCIDENTAL OR CONSEQUENTIAL DAMAGES (INCLUDING DAMAGES FOR LOSS OF BUSINESS, LOSS OF PROFITS, LITIGATION, OR THE LIKE), WHETHER BASED UPON BREACH OF CONTRACT, BREACH OF WARRANTY, TORT (INCLUDING NEGLIGENCE), PRODUCT LIABILITY OR OTHERWISE, EVEN IF ADVISED OF THE POSSIBILITY OF SUCH DAMAGES. THE FOREGOING NEGATION OF DAMAGES IS A FUNDAMENTAL ELEMENT OF THE USE OF THE CONTENTS HEREOF, AND THESE CONTENTS WOULD NOT BE PUBLISHED BY TIA WITHOUT SUCH LIMITATIONS.



# ADMINISTRATION STANDARD FOR TELECOMMUNICATIONS INFRASTRUCTURE

## Table of Contents

<b>Foreword</b> .....	<b>vii</b>
<b>Introduction</b> .....	<b>ix</b>
General .....	ix
Purpose .....	ix
Specification of criteria .....	x
Metric equivalents of US customary units .....	x
Life of this Standard .....	x
Use of legacy identifier formats .....	x
Elements of an Administration System .....	x
<b>1 SCOPE</b> .....	<b>1</b>
<b>2 NORMATIVE REFERENCES</b> .....	<b>1</b>
<b>3 DEFINITION OF TERMS, ACRONYMS AND ABBREVIATIONS, AND UNITS OF MEASURE</b> .....	<b>2</b>
3.1 General .....	2
3.2 Definition of terms .....	2
3.3 Acronyms and abbreviations .....	8
3.4 Units of measure .....	8
<b>4 CLASSES OF ADMINISTRATION</b> .....	<b>9</b>
4.1 General .....	9
4.2 Determination of class .....	9
4.2.1 Class 1 .....	9
4.2.2 Class 2 .....	9
4.2.3 Class 3 .....	10
4.2.4 Class 4 .....	10
4.3 Classes and associated identifiers .....	10
4.4 Labeling formats .....	10
4.5 ANSI/TIA-606-A and ISO/IEC TR 14763-2-1 compatible formats .....	11
4.6 Alternative label formats .....	16
<b>5 CLASS 1 ADMINISTRATION</b> .....	<b>17</b>
5.1 Infrastructure identifiers .....	17
5.1.1 Telecommunications space identifier .....	17
5.1.2 Cabinet and rack identifiers .....	18
5.1.3 Patch panel and termination block identifier .....	24
5.1.4 Patch panel port and termination block position identifiers .....	33
5.1.5 Cables between patch panels or termination blocks .....	34
5.1.6 Administration of pairs, strands, and groupings within a cable .....	37
5.1.7 Cabling Subsystem 1 link identifier .....	38
5.1.8 Equipment outlet and telecommunications outlet identifiers .....	40
5.1.9 Identifiers for consolidation points on Cabling Subsystem 1 links .....	41
5.1.10 Identifiers for zone distribution area ports .....	41
5.1.11 Identifiers for splices on Cabling Subsystem 1 links .....	42
5.1.12 TMGB identifier .....	43
5.1.13 TGB identifier .....	43

5.1.14	RGB identifier .....	44
5.1.15	Mesh-BN identifier .....	44
5.1.16	BCT identifier .....	45
5.1.17	TBB identifier .....	45
5.1.18	GE identifier .....	46
5.1.19	Identifier for bonding conductor attached to TMGB .....	46
5.1.20	Identifier for bonding conductor attached to TGB .....	47
5.1.21	Identifier for bonding conductor attached to mesh-BN.....	48
5.1.22	Identifier for bonding conductor attached to RGB .....	48
5.2	Required records .....	49
<b>6</b>	<b>CLASS 2 ADMINISTRATION.....</b>	<b>49</b>
6.1	Infrastructure identifiers .....	49
6.1.1	Building Cabling Subsystem 2 and 3 cable identifiers .....	50
6.1.2	Pairs, strands, and grouping identifiers for Building Cabling Subsystem 2 and 3 .....	51
6.1.3	Building Cabling Subsystem 2 and 3 splice identifier.....	51
6.1.4	Firestopping location identifier.....	52
6.2	Required records .....	53
6.2.1	TS records .....	53
6.2.2	Building Cabling Subsystem 2 and 3 cable records .....	53
6.2.3	TMGB records .....	54
6.2.4	TGB records .....	54
6.2.5	Firestopping records.....	54
<b>7</b>	<b>CLASS 3 ADMINISTRATION.....</b>	<b>55</b>
7.1	Infrastructure identifiers .....	55
7.1.1	Campus or site identifier.....	55
7.1.2	Building identifier .....	56
7.1.3	Inter-building cable identifier .....	56
7.1.4	Inter-building cable pair / port identifier .....	57
7.1.5	Inter-building cable splice identifier .....	57
7.2	Required records .....	58
7.2.1	Building records.....	58
7.2.2	Campus cable records .....	58
<b>8</b>	<b>CLASS 4 ADMINISTRATION.....</b>	<b>59</b>
8.1	Infrastructure identifiers .....	59
8.2	Required records .....	59
<b>9</b>	<b>OPTIONAL IDENTIFIERS FOR INFRASTRUCTURE ELEMENTS.....</b>	<b>59</b>
9.1	General.....	59
9.2	Absolute and partial identifiers .....	60
9.3	Outdoor telecommunications space identifiers .....	60
9.3.1	TIA-606-A compatible format .....	60
9.3.2	ISO/IEC compatible format.....	60
9.3.3	Implementation and labeling .....	60
9.4	Pathway identifiers.....	61
9.4.1	Intra-space pathway identifiers.....	61
9.4.2	Intra-building pathway identifiers.....	61
9.4.3	Building entrance pathway identifiers.....	62
9.4.4	Outside plant pathway identifiers .....	62
9.4.5	Campus entrance pathway identifiers .....	63
9.5	Examples of elements and identifiers.....	63



<b>10</b>	<b>COLOR-CODING IDENTIFICATION</b>	<b>67</b>
10.1	General	67
10.2	Color-coding of termination fields	67
10.2.1	General	67
10.2.2	Color-coding of specific termination fields	67
10.3	Color-coding in Cabling Subsystem 1 cabling	69
10.3.1	Cabling Subsystem 1 cabling components	69
10.3.2	Fiber cabling components	69
<b>11</b>	<b>PERMANENT LABELS</b>	<b>69</b>
11.1	Visibility and durability	69
11.2	Machine generation	69
<b>12</b>	<b>ADMINISTRATION SYSTEMS USING RECORDS, LINKAGES &amp; REPORTS</b>	<b>69</b>
12.1	General	69
12.2	Records	70
12.3	Linkages	70
12.4	Reports	70
12.5	Specialized software	70
<b>13</b>	<b>AUTOMATED INFRASTRUCTURE MANAGEMENT SYSTEMS</b>	<b>70</b>
13.1	General	70
13.2	Core functions of automated infrastructure management	70
13.3	Auxiliary functions	71
13.4	Usage recommendations	71
	<b>Annex A (informative) Identification of patch cords, equipment cords, and direct equipment-to-equipment cables</b>	<b>72</b>
A.1	Patch cord identifiers	72
A.1.1	TIA-606-A compatible format	72
A.1.2	ISO/IEC compatible format	72
A.1.3	Implementation and labeling	72
A.2	Equipment cord identifiers	72
A.2.1	TIA-606-A compatible format	72
A.2.2	ISO/IEC compatible format	73
A.2.3	Implementation and labeling	73
A.3	Direct equipment to equipment cable identifiers	73
A.3.1	TIA-606-A compatible format	73
A.3.2	ISO/IEC compatible format	73
A.3.3	Implementation and labeling	73
A.4	Labeling of patch cords, equipment cords, and direct equipment-to-equipment cables	73
A.5	Alternative Scheme for labeling of patch cords, equipment cords, and direct equipment-to-equipment cables	74
	<b>Annex B (informative) Telecommunications grounding system identification Example</b>	<b>75</b>
	<b>Annex C (informative) Graphical, symbology, and drawing elements of administration</b>	<b>76</b>
C.1	General	76
C.2	T-Series drawings	76
C.3	Layers	78
C.4	Line styles, pathway conditions, and drawing notes	80

C.5 Symbols .....82  
C.6 Sample drawings .....87  
**Annex D (informative) Bibliography and References .....91**

**List of Tables**

Table 1 - Identifiers grouped by class – ANSI/TIA-606-A compatible .....11  
Table 2 - Identifiers grouped by class – ISO/IEC TR 14763-2-1 compatible .....13  
Table 3 - Optional identifiers associated with pathway, device, and space elements.....66  
Table 4 - Example of termination field color-coding .....67  
Table 5 - Layers, element descriptions, colors, and line types.....78

**List of Figures**

Figure 1 – Illustrative relationship between the ANSI/TIA-568-C Series and other relevant TIA standards ..... viii  
Figure 2 – A representative model of typical telecommunications infrastructure elements for administration ..... xi  
Figure 3 – Elements of generic cabling topology ..... 3  
Figure 4 – Example of room grid coordinates .....19  
Figure 5 – Example of cabinet identifiers using grid .....20  
Figure 6 – Example of non-grid coordinates .....22  
Figure 7 – Example of telecommunications room cabinet and wall segment identifiers .....23  
Figure 8 – Sample rack and cabinet labeling .....24  
Figure 9 – Example of vertically aligned patch panel identification .....26  
Figure 10 – Labeling example for UTP patch panel with label fields .....28  
Figure 11 – Labeling example for UTP patch panel without patch panel ID label fields .....28  
Figure 12 – Labeling example of a fiber patch panel ignoring subpanels.....29  
Figure 13 – Labeling example of a fiber patch panel with subpanels .....29  
Figure 14 – Labeling example of a fiber patch panel with optional MDA and HDA identifiers ....30  
Figure 15 – Example of non-vertically aligned patch panel identification .....32  
Figure 16 – Optional symbol to indicate powered port or outlet .....34  
Figure 17 – Sample MPO/LC layout .....36  
Figure 18 – Sample MPO/LC labeling scheme .....36

Figure 19 – Sample MPO/LC labeling at LC end.....	37
Figure 20 - Example of color-coding of termination fields .....	68
Figure 21 – Equipment cord & patch cord labeling scheme.....	74
Figure 22 – telecommunications grounding system labeling example .....	75
Figure 23 – T0 and T1 line styles .....	80
Figure 24 - Pathway conditions and drawing notes .....	81
Figure 25 – T0 symbols.....	82
Figure 26 – T0 & T1 symbols .....	83
Figure 27 – Additional T0 & T1 symbols.....	84
Figure 28 - T2 symbols .....	85
Figure 29 - T3 symbols .....	86
Figure 30 - Example of T0 drawing level .....	87
Figure 31 - Example of T1 drawing level .....	88
Figure 32 - Example of T2 drawing level .....	89
Figure 33 - Example of T3 drawing level .....	90

## Foreword

(This foreword is not part of this Standard)

### Approval of this Standard

This Standard was approved by the Telecommunications Industry Association (TIA) Subcommittee TR-42.6, TIA Technical Engineering Committee TR-42, and the American National Standards Institute (ANSI).

TIA reviews standards every 5 years. At that time, standards are reaffirmed, rescinded, or revised according to the submitted updates. Updates to be included in the next revision of this Standard should be sent to the committee chair or to TIA.

### Contributing organizations

More than 30 organizations within the telecommunications industry contributed their expertise to the development of this Standard, including manufacturers, consultants, end users, distributors, and other organizations.

### Documents superseded

This Standard replaces ANSI/EIA/TIA-606-A dated May 2002 and its addenda.

### Significant technical changes from the previous edition

- a) Adopts identification scheme specified in TIA-606-A Addendum 1 for racks, cabinets, frames, wall sections, patch panels, and cabling within computer rooms and equipment rooms. Extends the use of these identifiers to locations outside computer rooms and equipment rooms.
- b) Creates new identification format for Cabling Subsystem 1 links, Cabling Subsystem 2 cables, Cabling Subsystem 3 cables, and campus cabling, but allows old identifiers for these elements to continue being used.
- c) Creates new identifiers for telecommunications outlets, equipment outlets, splices, consolidation points, and outdoor telecommunications spaces (maintenance holes, pedestals, hand holes, etc.).
- d) Extends telecommunications administration to all inter-building telecommunications cabling.
- e) Permits administration of Cabling Subsystem 2 and 3 cables by pair groups corresponding to ports rather than copper pairs or single fibers.
- f) Adds administration of telecommunications bonding and grounding systems beyond the TMGB and TGB.
- g) Permits existing identifier formats to continue to be used avoiding the need to create new identifiers and new labels for existing elements.
- h) Provides information on implementing automated infrastructure management systems.

### Relationship to other standards and documents

The following are related standards regarding various aspects of structured cabling that were developed and are maintained by Engineering Committee TIA TR-42.

- ANSI/TIA-568-C.0, *Generic Telecommunications Cabling For Customer Premises*
- ANSI/TIA-568-C.1, *Commercial Building Telecommunications Cabling Standard*

- ANSI/TIA-568-C.2, *Balanced Twisted-Pair Telecommunications Cabling and Components standard*
- ANSI/TIA-568-C.3, *Optical Fiber Cabling Components Standard*
- ANSI/TIA-569-C, *Telecommunications Pathways and Spaces*
- ANSI/TIA-607-B, *Telecommunications Bonding and Grounding (Earthing) for Customer Premises*
- ANSI/TIA-758-B, *Customer-Owned Outside Plant Telecommunications Infrastructure Standard*

Figure 1 is the schematic relationship between the ANSI/TIA-568-C series and other relevant standards.

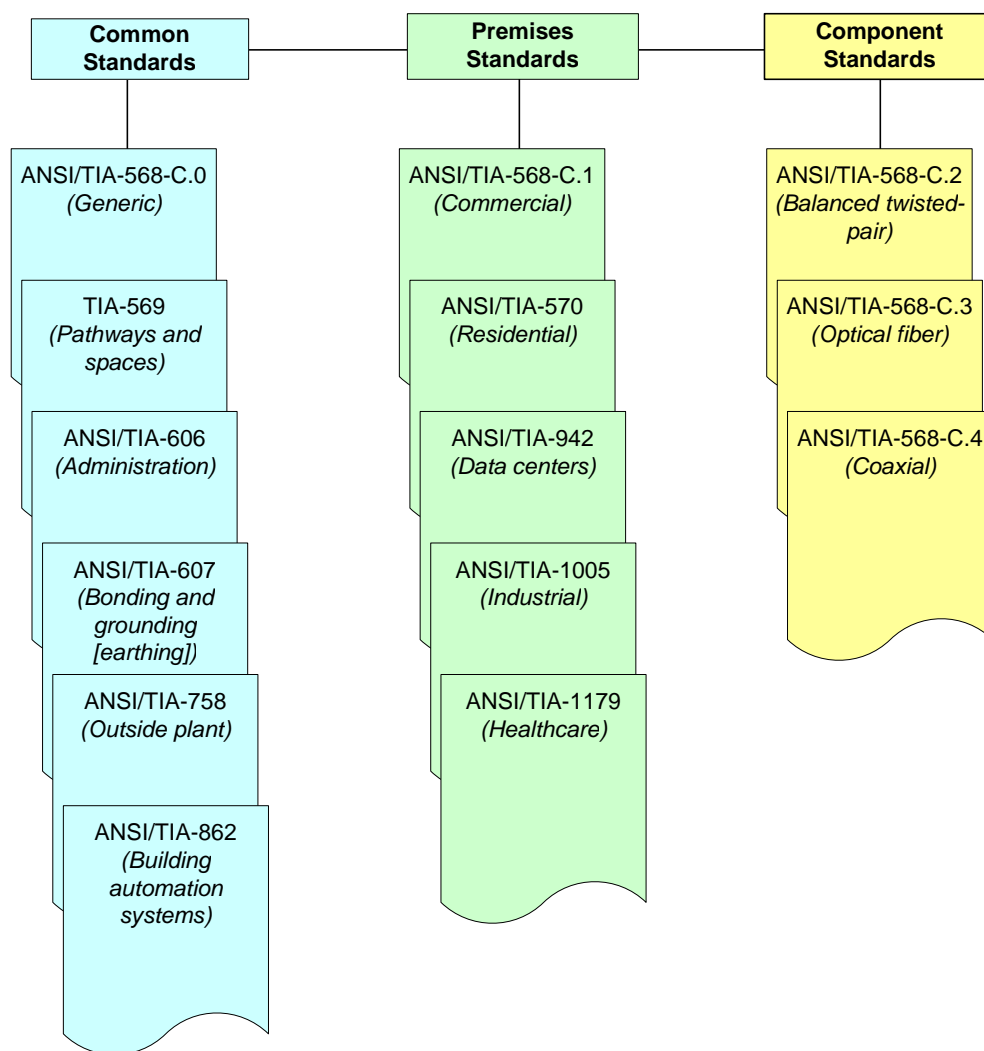

**Figure 1 – Illustrative relationship between the ANSI/TIA-568-C Series and other relevant TIA standards**

Useful supplements to this Standard are the BICSI *Telecommunications Distribution Methods Manual*, the *Outside Plant Design Reference Manual*, and the *Information Transport Systems Installation Methods Manual*. These manuals provide recommended practices and methods by which many of the requirements of this Standard may be implemented.

Other references are listed in Annex D.

### **Stencils used in figures**

Some figures in this document were created using stencils developed by NetZoom. This use of NetZoom shall not be considered as an endorsement by TIA.

### **Annexes**

Annexes A through D are informative and are not considered as requirements of this Standard.

## **Introduction**

### **General**

This Standard provides guidelines and choices of classes for the administration of the telecommunications infrastructure. The four classes of administration specified are based on the complexity of the infrastructure being administered. In addition, this Standard is modular and scalable to allow implementation of various portions of the administration system as desired. For example, a contractor placing the pathways may be responsible for recording pathway information. After the pathway has been placed, a different contractor installing the cabling may be responsible for recording cabling information. A third contractor might install firestopping and be responsible for recording information and labeling for that portion of the infrastructure. The system owner should coordinate among the various contractors to maintain a uniform method of administration as specified in this Standard.

### **Purpose**

This Standard specifies administration for a generic telecommunications cabling system that will support a multi-product, multi-vendor environment. It also provides information that may be used for the design of administration products.

This Standard provides a uniform administration approach that is independent of applications, which may change several times throughout the life of the telecommunications infrastructure. It establishes guidelines for owners, end users, manufacturers, consultants, contractors, designers, installers, and facilities administrators involved in the administration of the telecommunications infrastructure.

Use of this Standard is intended to increase the value of the system owner's investment in the infrastructure by reducing the labor expense of maintaining the system, by extending the useful economic life of the system, and by providing effective service to users.

The concepts outlined in this standard may be extended to other applications (e.g., building automation systems, security, and audio/visual) that are in harmony with the telecommunications topology.

### **Stewardship**

Telecommunications infrastructure affects raw material consumption. The infra-structure design and installation methods also influence product life and sustainability of electronic equipment life cycling. These aspects of telecommunications infrastructure impact our environment. Since building life cycles are typically planned for decades, technological electronic equipment upgrades are necessary. The telecommunications infrastructure design and installation process

magnifies the need for sustainable infrastructures with respect to building life, electronic equipment life cycling and considerations of effects on environmental waste. Telecommunications designers are encouraged to research local building practices for a sustainable environment and conservation of fossil fuels as part of the design process.

### **Specification of criteria**

Two categories of criteria are specified; mandatory and advisory. The mandatory requirements are designated by the word “shall”; advisory requirements are designated by the words “should,” “may,” or “desirable,” which are used interchangeably in this Standard.

Mandatory criteria generally apply to protection, performance, administration and compatibility; they specify the absolute minimum acceptable requirements. Advisory or desirable criteria are presented when their attainment will enhance the general performance of the cabling system in all its contemplated applications.

A note in the text, table, or figure is used for emphasis or for offering informative suggestions.

### **Metric equivalents of US customary units**

The dimensions in this Standard are metric or US customary with soft conversion to the other.

### **Life of this Standard**

This Standard is a living document. The criteria contained in this Standard are subject to revisions and updating as warranted by advances in building construction techniques and telecommunications technology.

### **Use of legacy identifier formats**

This Standard specifies two identifier formats, one fully backward compatible with legacy TIA-606-A identifiers and one based on TIA-606-A, but modified to be compatible with the ISO/IEC TR 14763-2-1 identifiers. New administration systems should use the identifier format compatible with the ISO/IEC TR 14763-2-1.

### **Elements of an administration system**

Figure 2 illustrates a representative model for generic telecommunications infrastructures for which this Standard specifies an administration system. The elements illustrated include:

- a) Cabling Subsystem 1 pathways and cabling;
- b) Cabling Subsystem 2 and 3 pathways and cabling;
- c) telecommunications bonding and grounding;
- d) spaces (e.g., entrance facility, telecommunications room, equipment room); and
- e) firestopping.

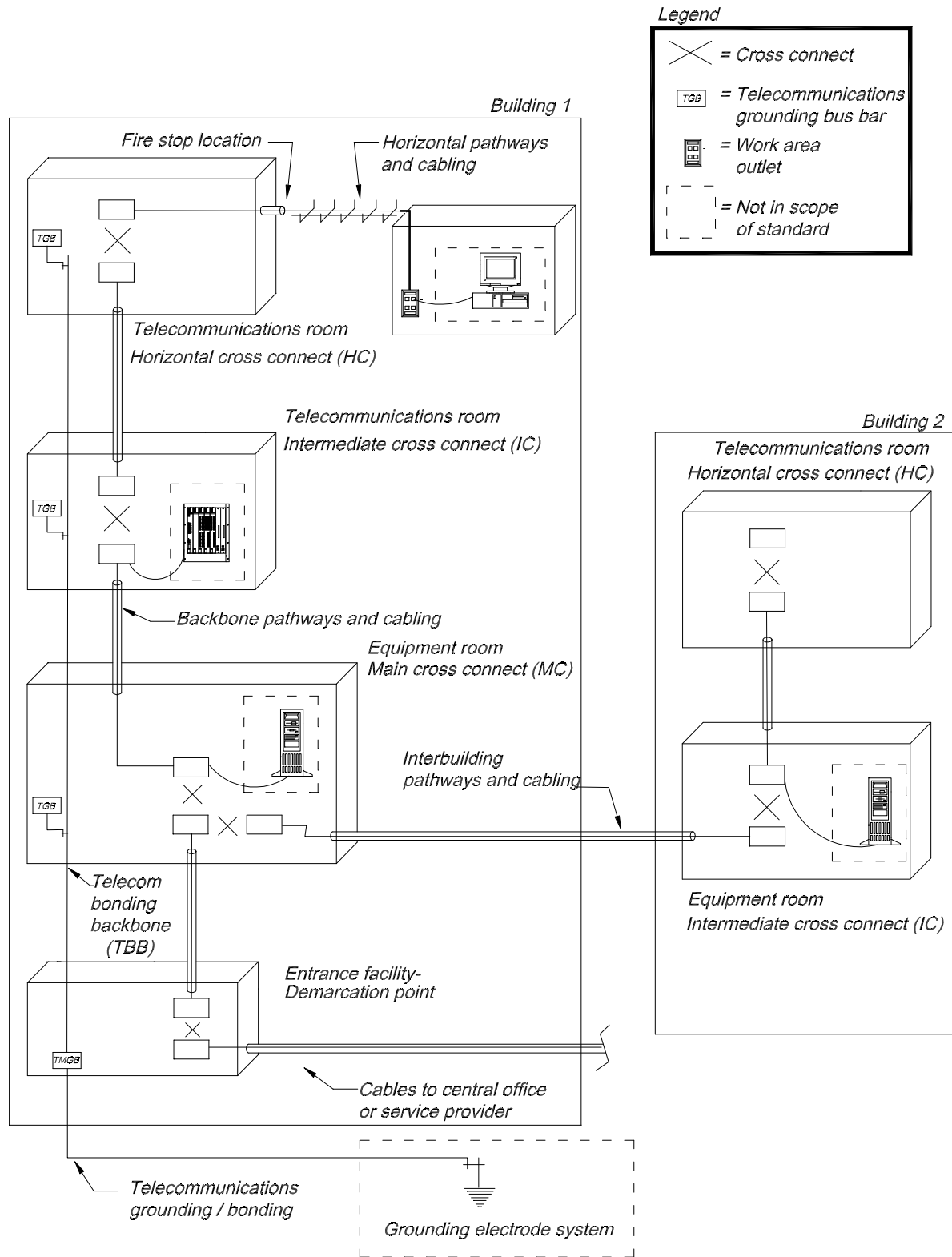

**Figure 2 – A representative model of typical telecommunications infrastructure elements for administration**





## 1 SCOPE

This Standard specifies administration systems for telecommunications infrastructure within buildings (including commercial, industrial, residential, and data center premises) and between buildings. This infrastructure may range in size from a building requiring a single telecommunications space (TS) and associated elements, to many TSs and associated elements in multiple campus locations. This Standard applies to administration of telecommunications infrastructure in existing, renovated, and new buildings.

This Standard addresses the administration of telecommunications infrastructure by:

- a) assigning identifiers to components of the infrastructure
- b) specifying elements of information that make up records for each identifier
- c) specifying relationships between these records to access the information they contain
- d) specifying reports presenting information on groups of records
- e) specifying graphical and symbolic requirements

This Standard does not replace any code, either partially or wholly.

## 2 NORMATIVE REFERENCES

The following standards contain provisions that, through reference in this text, constitute provisions of this Standard. At the time of publication of this Standard, the editions were valid. All standards are subject to revision; parties to agreements based on this Standard are encouraged to investigate the possibility of applying the most recent editions of standards indicated. ANSI and TIA maintain registers of currently valid national standards published by them.

- a) ANSI/TIA-568-C.0, *Customer-Owned Telecommunications Networks*
- b) ANSI/TIA-568-C.3, *Optical Fiber Cabling Component Standard*
- c) EIA/ECA-310-E: 2005, *Cabinets, Racks, Panels, and Associated Equipment*
- d) IEC 60297-3-100 2008: *Mechanical Structures for Electronic Equipment – Dimensions of Mechanical Structures of the 482,6 mm (19 in) Series – Part 3-100: Basic Dimensions of Front Panels, Subracks, Chassis, Racks and Cabinets.*
- e) ISO/IEC TR 14763-2-1, *Generic cabling – Implementation and operation of premises cabling – Identifiers within administration systems.*

### 3 DEFINITION OF TERMS, ACRONYMS AND ABBREVIATIONS, AND UNITS OF MEASURE

#### 3.1 General

The generic definitions in this clause have been formulated for use by the entire family of telecommunications infrastructure standards. Specific requirements are found in the normative clauses of this Standard.

#### 3.2 Definition of terms

For the purposes of this Standard, the following definitions apply.

**access provider:** The operator of any facility that is used to convey telecommunications signals to and from a customer premises.

**adapter; optical fiber duplex:** A mechanical device designed to align and join two optical fiber connectors (plugs) to form an optical connection.

**administration:** The method for labeling, identification, documentation and usage needed to implement moves, additions and changes of the telecommunications infrastructure.

**aerial cable:** Telecommunications cable installed on aerial supporting structures such as poles, sides of buildings, and other structures.

**backbone:** A facility (e.g., pathway, cable or bonding conductor) for Cabling Subsystem 2 and Cabling Subsystem 3.

**backbone cable:** See **backbone**.

**bonding conductor for telecommunications (BCT):** A conductor that interconnects the telecommunications bonding infrastructure to the building's service equipment (power) ground.

**bonding conductor:** A conductor that joins metallic parts to form an electrically conductive path.

**cabinet:** A container that may enclose connection devices, terminations, apparatus, wiring, and equipment.

**cable:** An assembly of one or more insulated conductors or optical fibers, within an enveloping sheath.

**cable run:** A length of installed media, which may include other components along its path.

**cabling:** A combination of all cables, jumpers, cords, and connecting hardware.

**Cabling Subsystem 1:** Cabling from the equipment outlet to Distributor A, Distributor B, or Distributor C.

**Cabling Subsystem 2:** Cabling between Distributor A and either Distributor B or Distributor C (if Distributor B is not implemented).

**Cabling Subsystem 3:** Cabling between Distributor B and Distributor C.

**Note:** See figure 3 below for an illustration of the generic cabling topology for **Cabling Subsystem 1, Cabling Subsystem 2, Cabling Subsystem 3, Distributor A, Distributor B, Distributor C**, an optional **consolidation point** and the **equipment outlet**.

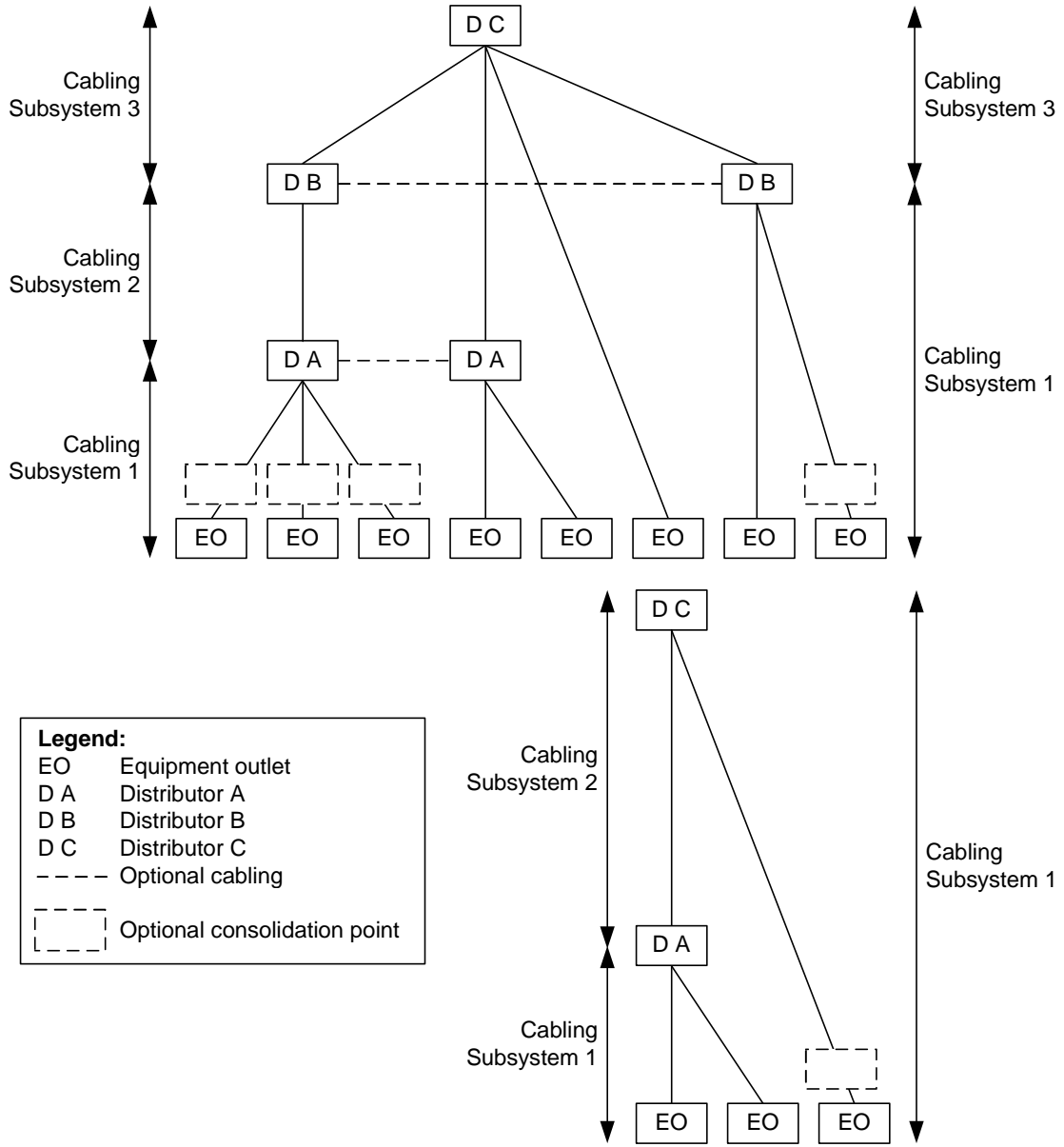

**Figure 3 – Elements of generic cabling topology**

**campus:** Buildings and grounds having legal contiguous interconnection.

**channel:** The end-to-end transmission path between two points at which application-specific equipment is connected.

**common bonding network (CBN):** The set of metallic components that are interconnected to form the principle means for effectively bonding equipment inside a building to the grounding electrode system.

**common equipment room (telecommunications):** An enclosed space used for equipment and backbone interconnections for more than one tenant in a building.

**common telecommunications room:** An enclosed space used for backbone interconnections for more than one tenant in a building, which may also house equipment.

**computer room:** An architectural space whose primary function is to accommodate data processing equipment.

**conduit:** (1) A raceway of circular cross-section. (2) A structure containing one or more ducts.

Editorial note - For the purposes of these Standards the term conduit includes electrical metallic tubing (EMT) or electrical non-metallic tubing (ENT).

**conduit system:** Any combination of ducts, conduits, maintenance holes, handholes and vaults joined to form an integrated whole.

**connecting hardware:** A device providing mechanical cable terminations.

**connector (plug), duplex; optical fiber:** A remateable device that terminates two fibers and mates with a duplex receptacle.

**consolidation point:** A connection facility within Cabling Subsystem 1 for interconnection of cables extending from building pathways to the equipment outlet.

**cord (telecommunications):** An assembly of cord cable with a plug on one or both ends.

**cord cable:** A cable used to construct patch, work area, and equipment cords.

**cross-connect:** A facility enabling the termination of cable elements and their interconnection or cross-connection.

**cross-connection:** A connection scheme between cabling runs, subsystems, and equipment using patch cords or jumpers that attach to connecting hardware on each end.

**customer premises:** Building(s), grounds and appurtenances (belongings) under the control of the customer.

**data center:** A building or portion of a building whose primary function is to house a computer room and its support areas.

**demarcation point:** A point where the operational control or ownership changes.

**direct-buried cable:** A telecommunications cable designed to be installed under the surface of the earth, in direct contact with the soil.

**Distributor A:** Optional connection facility in a hierarchical star topology that is cabled between the equipment outlet and Distributor B or Distributor C.

**Distributor B:** Optional intermediate connection facility in a hierarchical star topology that is cabled to Distributor C.

**Distributor C:** Central connection facility in a hierarchical star topology.

**duct:** (1) A single enclosed raceway for conductors or cables (See also **conduit, raceway**). (2) A single enclosed raceway for wires or cables usually used in soil or concrete. (3) An enclosed air flow path, generally part of the HVAC system of a building.

**enclosure, telecommunications:** A case or housing that may contain telecommunications equipment, cable terminations, or horizontal cross-connect cabling.

**end user:** The owner or user of the premises cabling system.

**entrance facility (telecommunications):** An entrance to a building for both public and private network service cables (including wireless) including the entrance point of the building and continuing to the entrance room or space.

**equipment cord:** See **cord**.

**equipment outlet:** Outermost connection facility in a hierarchical star topology.

**equipment room (telecommunications):** An environmentally controlled centralized space for telecommunications equipment that usually houses Distributor B or Distributor C.

**firestop:** A fire-rated material, device, or assembly of parts installed in a penetration of a fire-rated barrier.

**firestopping:** The process of installing listed, fire-rated materials into penetrations in fire-rated barriers to reestablish the fire-resistance rating of the barrier.

**grounding electrode:** A conductor used to connect the grounding electrode to the building's main grounding busbar.

**grounding electrode conductor:** The conductor used to connect the grounding electrode to the equipment grounding conductor, or to the grounded conductor of the circuit at the service equipment, or at the source of a separately derived system.

**grounding equalizer (GE):** The conductor that interconnects elements of the telecommunications grounding infrastructure (formerly TBBIBC).

**handhole:** A structure similar to a small maintenance hole in which it is expected that a person cannot enter to perform work.

**horizontal cabling:** Cabling Subsystem 1.

**horizontal connection point:** A location for connections between horizontal cables that extend from building pathways and horizontal cables that extend to building automation systems devices and equipment.

**horizontal cross-connect:** See Distributor A.

**horizontal distribution area:** A space in a computer room where a horizontal cross-connect is located.

**hybrid cable:** An assembly of two or more cables, of the same or different types or categories, covered by one overall sheath.

**identifier:** An item of information that links a specific element of the telecommunications infrastructure with its corresponding record.

**infrastructure (telecommunications):** A collection of those telecommunications components, excluding equipment, that together provide the basic support for the distribution of all information within a building or campus.

**interconnection:** A connection scheme that employs connecting hardware for the direct connection of a cable to another cable without a patch cord or jumper.

**innerduct:** A nonmetallic raceway, usually circular, placed within a larger raceway.

**intermediate cross-connect:** See Distributor B.

**insulation displacement connection:** An electrical connection made by inserting an insulated wire into a metallic slot.

**insulation displacement contact:** See insulation displacement termination.

**jumper:** (1) An assembly of twisted-pairs without connectors, used to join telecommunications circuits/links at the cross-connect. (2) A length of optical fiber cable with a connector plug on each end.

**junction box:** A location in the pathway system that allows transition of pathways and access to

cables.

**link:** A transmission path between two points, not including equipment and cords.

**linkage:** A connection between a record and an identifier or between records.

**main cross-connect:** See Distributor C.

**main distribution area:** The space in a computer room where the main cross-connect is located.

**maintenance hole (telecommunications):** A vault located in the ground or earth as part of an underground duct system and used to facilitate placing, connectorization, and maintenance of cables as well as the placing of associated equipment, in which it is expected that a person will enter to perform work.

**media (telecommunications):** Wire, cable, or conductors used for telecommunications.

**modular jack:** A female telecommunications connector that may be keyed or unkeyed and may have 6 or 8 contact positions, but not all the positions need be equipped with jack contacts.

**multi-user telecommunications outlet assembly:** A grouping in one location of several telecommunications outlet/connectors.

**optical fiber:** Any filament made of dielectric materials that guides light.

**optical fiber cable:** An assembly consisting of one or more optical fibers.

**optical fiber duplex connection:** A mated assembly of two duplex connectors and a duplex adapter.

**outlet box (telecommunications):** A housing used to hold telecommunications outlet/connectors.

**outside plant:** Telecommunications infrastructure designed for installation exterior to buildings.

**patch cord:** 1) A length of cable with a plug on one or both ends. 2) A length of optical fiber cable with a connector on each end.

**patch panel:** A connecting hardware system that facilitates cable termination and cabling administration using patch cords.

**pathway:** A facility for the placement of telecommunications cable.

**penetration:** An opening in a fire-rated barrier.

**port:** A connection point for one or more conductors or fibers.

**private branch exchange:** A private telecommunications switching system.

**raceway:** Any enclosed channel designed for holding wires or cables.

**rack grounding bar (RGB):** A grounding busbar located in a rack, cabinet, or frame for grounding of equipment in the cabinet, rack, or frame.

**rack unit:** 450.85 mm (1.75 inches) of vertical mounting space in an IEC 60297-3-100 or EIA/ECA-310-E compliant cabinet or rack.

**record:** A collection of detailed information related to a specific element of the telecommunications infrastructure.

**report:** A presentation of a collection of information from the various records.

**room, telecommunications:** An enclosed space for housing telecommunications equipment, cable terminations, and cross-connect cabling that is the recognized location of the horizontal cross-connect.

**service provider:** The operator of any service that furnishes telecommunications content (transmissions) delivered over access provider facilities.

**space (telecommunications):** An area used for housing the installation and termination of telecommunications equipment and cable, e.g., common equipment rooms, equipment rooms, common telecommunications rooms, telecommunications rooms, work areas, and maintenance holes/handholes.

**splice:** A joining of conductors in a splice closure, meant to be permanent.

**splice box:** A box, located in a pathway run, intended to house a cable splice.

**splice closure:** A device used to protect a splice.

**telecommunications:** Any transmission, emission, and reception of signs, signals, writings, images, and sounds, that is, information of any nature by cable, radio, optical, or other electromagnetic systems.

**telecommunications bonding backbone (TBB):** A conductor that interconnects the telecommunications main grounding busbar (TMGB) to the telecommunications grounding busbar (TGB).

**telecommunications grounding busbar (TGB):** The interface to the building telecommunications grounding system generally located in telecommunications room. A common point of connection for telecommunications and system equipment bonding to ground, and located in the telecommunications room, equipment room, computer room, entrance room, and other telecommunications spaces.

**telecommunications main grounding busbar (TMGB):** A busbar placed in a convenient and accessible location and bonded by means of the bonding conductor for telecommunications to the building service equipment (power) ground.

**telecommunications infrastructure:** See **infrastructure (telecommunications)**.

**telecommunications media:** See **media (telecommunications)**.

**telecommunications space:** See **space (telecommunications)**.

**termination block:** A connection hardware system that facilitates cable termination and cabling administration using jumpers.

**termination position:** A discrete element of termination hardware where telecommunications conductors are terminated.

**topology:** The physical or logical arrangement of a telecommunications system.

**work area (work station):** A building space where the occupants interact with telecommunications terminal equipment.



### 3.3 Acronyms and abbreviations

The following acronyms and abbreviations are used in this Standard:

AHJ	authority having jurisdiction
AIM	automated infrastructure management
ANSI	American National Standards Institute
BCT	bonding conductor for telecommunications
CER	common equipment room
CP	consolidation point
CTR	common telecommunications room
EF	entrance facility
ER	equipment room
GE	grounding equalizer
HDA	horizontal distribution area
IDC	insulation displacement contact
LAN	Local Area Network
mesh-BN	mesh bonding network
MDA	main distribution area
PDU	power distribution unit
PBX	private branch exchange
RGB	rack grounding busbar
TBB	telecommunications bonding backbone
TGB	telecommunications grounding busbar
TIA	Telecommunications Industry Association
TMGB	telecommunications main grounding busbar
TR	telecommunications room
TS	telecommunications space
UTP	unshielded twisted pair

### 3.4 Units of measure

The following units of measure are used in this Standard:

cm	centimeter
in	inch
μm	micrometer or micron
mm	millimeter
m	meter
U	rack unit

## 4 CLASSES OF ADMINISTRATION

### 4.1 General

Four classes of administration are specified in this Standard to accommodate diverse degrees of complexity present in telecommunications infrastructure. The specifications for each class include requirements for identifiers, records, and labeling. An administration system shall provide a method to find the record associated with any specific identifier.

An administration system may be managed using a paper-based system, general purpose spreadsheet software, specialized software, or Automated Infrastructure Management (AIM) systems. In a general purpose spreadsheet implementation, each required identifier with its associated record makes up a row and each column contains a particular item of information from the record. Administration for complex cabling systems may require specialized software or AIM systems. Specialized software shall provide reports comprising information from groups of records.

Drawings should be available showing all identified elements of infrastructure. Refer to Annex C for examples and further information.

The reader shall consult the Authority Having Jurisdiction (AHJ) concerning applicable codes that may impact the use of this Standard.

### 4.2 Determination of class

The most relevant factors in determining the minimum class of administration are the size and complexity of the infrastructure. The number of telecommunications spaces (TS), such as equipment room (ER), telecommunications room (TR), access provider spaces, service provider spaces, common distributor room, and entrance facility (EF) spaces, is one indicator of complexity.

Classes are scalable and allow expansion without requiring changes to existing identifiers or labels. For mission critical systems, buildings over 7000 m<sup>2</sup> (75 000 ft<sup>2</sup>), or multi-tenant buildings, administration of pathways and spaces and outside plant elements is strongly recommended. See clause 9.

#### 4.2.1 Class 1

Class 1 addresses the administration needs of a premises that is served by a single ER. This ER is the only TS administered whereas there are no TRs and no Cabling Subsystem 2 or 3 cabling, or outside plant cabling systems to administer. Simple cable pathways will generally be intuitively understood and need not be administered. In order to administer cable pathways or firestopping locations, a class 2 or higher administration system should be used. Class 1 will typically be managed using a paper-based system or with general purpose spreadsheet software. Class 1 administration is specified in clause 5.

#### 4.2.2 Class 2

Class 2 administration provides for the telecommunications infrastructure administration needs of a single building or of a tenant that is served by a single or multiple TSs (e.g., an ER with one or more TRs) within a single building. Class 2 administration includes all elements of class 1 administration, plus identifiers for Cabling Subsystem 2 and 3 cabling, multiple-element bonding and grounding systems, and firestopping. Cable pathways may be intuitively understood so administration of these elements is optional. Class 2 may be managed with general purpose

spreadsheet software, specialized software, or AIM systems. Class 2 administration is specified in clause 6.

#### **4.2.3 Class 3**

Class 3 administration addresses the needs of a campus, including its buildings and outside plant elements. Class 3 administration includes all elements of class 2 administration, plus identifiers for buildings and campus cabling. Administration of building pathways and spaces, and outside plant elements is recommended. Class 3 may be managed with general purpose spreadsheet software, specialized software, or AIM systems. Class 3 administration is specified in clause 7.

#### **4.2.4 Class 4**

Class 4 administration addresses the needs of a multi-campus/multi-site system. Class 4 administration includes all elements of class 3 administration, plus an identifier for each site, and optional identifiers for inter-campus elements, such as wide area network connections. For mission critical systems, large buildings, or multi-tenant buildings, administration of pathways and spaces and outside plant elements is strongly recommended. See clause 9. Class 4 may be managed with general purpose spreadsheet software, specialized software, or AIM systems. Class 4 administration is specified in clause 8.

### **4.3 Classes and associated identifiers**

An identifier is associated with each element of a telecommunications infrastructure to be administered. A unique identifier, or a combination of identifiers constructed so as to uniquely refer to a particular element, serves as the key to finding the record of information related to that element.

### **4.4 Labeling formats**

Labels do not need to include full identifiers. Only a portion of the identifiers needed to identify the component within the space it is located are required.

For example, the full identifier for a cabinet in building SFO2, room 1DC, coordinate location AD02 is:

SFO2-1DC.AD02

However, since the building and room name should be obvious to someone working in the room, the cabinet would be labeled:

AD02

Similarly, a cable between two cabinets within the same room would not need to include the building and room name in the label. So the cable between cabinet AD02 rack unit position 35 ports 1-12 to cabinet AG03 rack unit position 35 ports 1-12 within room 1DC in building SF02 would have the full identifier:

SFO2-1DC.AD02-35:01-12 / SF02-1DC.AG03-35:01-12

However, the label would be:

AD02-35:01-12 / AG03-35:01-12

Additionally, the delimiters used for labels need not be the same ones used for the identifiers, however the delimiters used for labels shall be consistently used throughout the enterprise. Thus, for the example above, 'p' or 'ports' may be used instead of the colon ':' to indicate ports on labels:

AD02-35 ports1-12 / AG03-35 ports1-12

#### 4.5 ANSI/TIA-606-A and ISO/IEC TR 14763-2-1 compatible formats

This standard specifies two formats for identifiers:

1. A format that is backward-compatible with the format specified in ANSI/TIA-606-A. This format should be used for existing administration systems that use ANSI/TIA-606-A identifiers.
2. A format that is compatible with the format specified in ISO/IEC TR 14763-2-1.

Table 1 illustrates ANSI/TIA-606-A compatible identifiers for elements of telecommunications infrastructure grouped by class. Table 2 is a similar table, but for ISO/IEC TR 14763-2-1 compatible identifiers.

**Table 1 - Identifiers grouped by class – ANSI/TIA-606-A compatible**

Identifier	Text Clauses	Description of Identifier	Class of administration			
			1	2	3	4
[[c-]b-][f]s	5.1.1	telecommunications space (TS)	R	R	R	R
[[[c-]b-][f]s.][x]y	5.1.2	cabinet, rack, enclosure, wall segment	R	R	R	R
[[[c-]b-][f]s.][x]y-r <sub>1</sub> [_r <sub>2</sub> ]	5.1.3	patch panel or termination block	R	R	R	R
[[[c-]b-][f]s.][x]y-r <sub>1</sub> [_r <sub>2</sub> ]:P	5.1.4	port on patch panel or termination on termination block	R	R	R	R
[[[c <sub>1</sub> -]b <sub>1</sub> -][f <sub>1</sub> ]s <sub>1</sub> .][x <sub>1</sub> ]y <sub>1</sub> -r <sub>1</sub> [_r <sub>2</sub> ]:P <sub>1</sub> [-P <sub>2</sub> ] / [[[c <sub>2</sub> -]b <sub>2</sub> -][f <sub>2</sub> ]s <sub>2</sub> .][x <sub>2</sub> ]y <sub>2</sub> -r <sub>3</sub> [_r <sub>4</sub> ]:P <sub>3</sub> [-P <sub>4</sub> ]	5.1.5	Cabling Subsystem 2 or 3 (backbone) cable or cable between cabinets, racks, enclosures, or wall segments	O	R	R	R
[[[c <sub>1</sub> -]b <sub>1</sub> -][f <sub>1</sub> ]s <sub>1</sub> .][x <sub>1</sub> ]y <sub>1</sub> -r <sub>1</sub> [_r <sub>2</sub> ]:P <sub>1</sub> / [[[c <sub>2</sub> -]b <sub>2</sub> -][f <sub>2</sub> ]s <sub>2</sub> .][x <sub>2</sub> ]y <sub>2</sub> -r <sub>3</sub> [_r <sub>4</sub> ]:P <sub>3</sub>	5.1.6	Port within Cabling Subsystem 2 or 3 cable or cable within distributor, telecommunications room, equipment room, or computer room	O	R	R	R
[[[c <sub>1</sub> -]b <sub>1</sub> -][f <sub>1</sub> ]s <sub>1</sub> .][x <sub>1</sub> ]y <sub>1</sub> -r <sub>1</sub> [_r <sub>2</sub> ]:P <sub>1</sub> / [[[c <sub>2</sub> -]b <sub>2</sub> -][f <sub>2</sub> ]s <sub>2</sub> .][x <sub>2</sub> ]y <sub>2</sub> -r <sub>3</sub> [_r <sub>4</sub> ]:P <sub>3</sub> or [[[c-]b-][f]s-an	5.1.7	Cabling Subsystem 1 (horizontal) link	R	R	R	R
[[[c <sub>2</sub> -]b <sub>2</sub> -][f <sub>2</sub> ]s <sub>2</sub> .][x <sub>2</sub> ]y <sub>2</sub> -r <sub>3</sub> [_r <sub>4</sub> ]:P <sub>2</sub> or [[[c-]b-][f]s-an=XO	5.1.8	Equipment outlet or telecommunications outlet	O	O	O	O
[[[c-]b-][f]s-an=XC[:P <sub>5</sub> ]	5.1.8.3	Consolidation point	O	O	O	O
[[[c <sub>1</sub> -]b <sub>1</sub> -][f <sub>1</sub> ]s <sub>1</sub> .][x <sub>1</sub> ]y <sub>1</sub> -r <sub>1</sub> [_r <sub>2</sub> ]:P <sub>1</sub> / [[[c <sub>2</sub> -]b <sub>2</sub> -][f <sub>2</sub> ]s <sub>2</sub> .][x <sub>2</sub> ]y <sub>2</sub> -r <sub>3</sub> [_r <sub>4</sub> ]:P <sub>3</sub> =XL[:P <sub>5</sub> ]	5.1.10	Port in ZDA in a data center	O	O	O	O
[[[c <sub>1</sub> -]b <sub>1</sub> -][f <sub>1</sub> ]s <sub>1</sub> .][x <sub>1</sub> ]y <sub>1</sub> -r <sub>1</sub> [_r <sub>2</sub> ]:P <sub>1</sub> / [[[c <sub>2</sub> -]b <sub>2</sub> -][f <sub>2</sub> ]s <sub>2</sub> .][x <sub>2</sub> ]y <sub>2</sub> -r <sub>3</sub> [_r <sub>4</sub> ]:P <sub>3</sub> =XSz or [[[c-]b-][f]s-an=XSz	5.1.11	Splice in Cabling Subsystem 1 link	O	O	O	O
[[c <sub>M</sub> -]b <sub>M</sub> -][f <sub>M</sub> ]s <sub>M</sub> -TMGB	5.1.12	TMGB - telecommunications main grounding busbar	R	R	R	R
[[c <sub>T</sub> -]b <sub>T</sub> -][f <sub>T</sub> ]s <sub>T</sub> -TGB[i]	5.1.13	TGB - telecommunications grounding busbar	R	R	R	R
[[[c-]b-][f]s.][x]y=RGB[i]	5.1.14	RGB - rack grounding busbar	O	O	O	O
[[[c-]b-][f]s=MBN	5.1.15	mesh-BN - mesh bonding network	O	O	O	O

Identifier	Text Clauses	Description of Identifier	Class of administration			
			1	2	3	4
$[[c_M-]b_M-][f_M]S_M / [[c_E-]b_E-][f_E]S_E=BCT$	5.1.16	BCT - bonding conductor for telecommunications	R	R	R	R
$[[c_M-]b_M-][f_M]S_M-TMGB / [[c_2-]b_2-][f_2]S_2-TGB[i_2]$ or $[[c_1-]b_1-][f_1]S_1-TGB[i_1] / [[c_2-]b_2-][f_2]S_2-TGB[i_2]$	5.1.17	TBB - telecommunications bonding backbone	O	R	R	R
$[[c_1-]b_1-][f_1]S_1-TGB[i_1] / [[c_2-]b_2-][f_2]S_2-TGB[i_2]$	5.1.18	GE - grounding equalizer	O	R	R	R
$[[c_M-]b_M-][f_M]S_M-TMGB / object$	5.1.19	Bonding conductor from <i>object</i> to TMGB	R	R	R	R
$[[c_T-]b_T-][f_T]S_T-TGB[i] / object$	5.1.20	Bonding conductor from <i>object</i> to TGB	R	R	R	R
$[[c-]b-][f]S=MBN / object$	5.1.21	Bonding conductor from <i>object</i> to mesh-BN	O	O	O	O
$[[[c-]b-][f]S].[x]y=RGB[j] / object$	5.1.22	Bonding conductor from <i>object</i> to RGB	O	O	O	O
$[[c_1-]b_1-][f_1]S_1.[x_1]y_1-r_1[_r_2]:P_1[-P_2] / [[c_2-]b_2-][f_2]S_2.[x_2]y_2-r_3[_r_4]:P_3[-P_4]$ or $f_1S_1/f_2S_2-n$	6.1.1	building Cabling Subsystem 2 or 3 (backbone) cable	O	R	R	R
$[[c_1-]b_1-][f_1]S_1.[x_1]y_1-r_1[_r_2]:P_1 / [[c_2-]b_2-][f_2]S_2.[x_2]y_2-r_3[_r_4]:P_3$ or $f_1S_1 / f_2S_2-n.d$	6.1.2	building Cabling Subsystem 2 or 3 pair / port	O	R	R	R
$[[c_1-]b_1-][f_1]S_1.[x_1]y_1-r_1[_r_2]:P_1 / [[c_2-]b_2-][f_2]S_2.[x_2]y_2-r_3[_r_4]:P_3=XSz(g)$ or $f_1S_1 / f_2S_2-n.d=XSz(g)$	6.1.3	building Cabling Subsystem 2 or 3 cable splice	O	O	O	O
$[[c_1-]b_1-][f_1]S_1 / [[c_2-]b_2-][f_2]S_2 =U(n(d))=F[m]$ or $f-FSLn(h)$	6.1.4	firestop location	O	R	R	R
c	7.1.1	campus or site	O	O	O	R
$[c-]b$	7.1.2	building	O	O	R	R
$[c_1-]b_1-[f_1]S_1.[x_1]y_1-r_1[_r_2]:P_1[-P_2] / [c_2-]b_2-[f_2]S_2.[x_2]y_2-r_3[_r_4]:P_3[-P_4]$ or $[c_1-]b_1-[f_1]S_1 / [c_2-]b_2-[f_2]S_2-n$	7.1.3	Inter-building cable	O	O	R	R
$[c_1-]b_1-[f_1]S_1.[x_1]y_1-r_1[_r_2]:P_1 / [c_2-]b_2-[f_2]S_2.[x_2]y_2-r_3[_r_4]:P_3$ or $[c_1-]b_1-[f_1]S_1 / [c_2-]b_2-[f_2]S_2-n.d$	7.1.4	Inter-building cable pair / port	O	O	R	R
$[c_1-]b_1-[f_1]S_1.[x_1]y_1-r_1[_r_2]:P_1 / [c_2-]b_2-[f_2]S_2.[x_2]y_2-r_3[_r_4]:P_3=XSz(g)$ or $[c_1-]b_1-[f_1]S_1 / [c_2-]b_2-[f_2]S_2-n.d=XSz(g)$	7.1.5	Inter-building cable splice	O	O	O	O
$c-\pi(g)$ or $c-UUU(g)$	9.3	Outdoor telecommunications space (e.g., maintenance holes, handholes, pedestals, outdoor cabinets).	O	O	O	O

Identifier	Text Clauses	Description of Identifier	Class of administration			
			1	2	3	4
$[[[c_1-b_1][f_1]s_1][x_1]y_1 / [[c_1-b_1][f_1]s_1][x_2]y_2=U(n(d))$ or $[[c-b][f]s-UUU.n.d][(q)]$	9.4.1	intra-space pathway	O	O	O	O
$[[[c_1-b_1][f_1]s_1 / [[c_1-b_1][f_2]s_2=U(n(d))$ or $[[c_1-b_1][f_1]s_1/[f_2]s_2-UUU.n.d][(q)]$	9.4.2	building pathway	O	O	O	O
$[c_1-b_1-[f_1]s_1=U(n(d))$ or $[c-b][f]s-EN.n.d][(q)]$	9.4.3	building entrance pathway	O	O	O	O
$[c_1-b_1-[f_1]s_1 / [c_2-b_2-[f_2]s_2]=U(n(d))$ or $c-UUU.n.d][(q)]$	9.4.4	outside plant pathway Outdoor telecommunications space Identifier [c]-T[(g)] may be used in place of building identifier [c]-b-[f]s	O	O	O	O
$c-T[(g)]=U(n(d))$ or $c-EN.n.d][(q)]$	9.4.5	campus entrance pathway	O	O	O	O
$[[[c_1-b_1][f_1]s_1][x_1]y_1-r_1[-r_2]:P_1 \setminus$ $[[[c_2-b_1][f_2]s_2][x_2]y_2-r_3[-r_4]:P_3$ or $[[f_1]s_1][x_1]y_1-a_1:P_1 \setminus [[f_2]s_2][x_2]y_2-a_2:P_2$	A.1	patch cord	O	O	O	O
$[[[c_1-b_1][f_1]s_1][x_1]y_1-r_1[-r_2]:P_1 \setminus$ $[[[c_2-b_1][f_2]s_2][x_2]y_2-e_2-s_2:P_2$ or $[[f_1]s_1][x_1]y_1-a_1:P_1 \setminus [[f_2]s_2][x_2]y_2-e_2-s_2:P_2$	A.2	equipment cord	O	O	O	O
$[[[c_1-b_1][f_1]s_1][x_1]y_1-e_1-s_1:P_1 \setminus$ $[[[c_2-b_2][f_2]s_2][x_2]y_2-e_2-s_2:P_2$ or $[[f_1]s_1][x_1]y_1-e_1-s_1:P_1 \setminus [[f_2]s_2][x_2]y_2-e_2-s_2:P_2$	A.3	direct cable between equipment	O	O	O	O

Table 2 - Identifiers grouped by class – ISO/IEC TR 14763-2-1 compatible

Identifier	Text Clauses	Description of Identifier	Class of administration			
			1	2	3	4
$[[+c]+b]+[f]s$	5.1.1	telecommunications space (TS)	R	R	R	R
$[[[+c]+b]+[f]s].[x]y$	5.1.2	cabinet, rack, enclosure, wall segment	R	R	R	R
$[[[+c]+b]+[f]s].[x]y+r_1[-r_2]$	5.1.3	patch panel or termination block	R	R	R	R
$[[[+c]+b]+[f]s].[x]y+r_1[-r_2]:P$	5.1.4	port on patch panel or termination on termination block	R	R	R	R
$[[[+c_1+b_1]+[f_1]s_1][x_1]y_1+r_1[-r_2]:P_1[-P_2] /$ $[[[+c_2+b_2]+[f_2]s_2][x_2]y_2+r_3[-r_4]:P_3[-P_4]$	5.1.5	Cabling Subsystem 2 or 3 (backbone) cable or cable between cabinets, racks, enclosures, or wall segments	O	R	R	R
$[[[+c_1+b_1]+[f_1]s_1][x_1]y_1+r_1[-r_2]:P_1 /$ $[[[+c_2+b_2]+[f_2]s_2][x_2]y_2+r_3[-r_4]:P_3$	5.1.6	Port within Cabling Subsystem 2 or 3 cable or cable within distributor, telecommunications room, equipment room, or computer room	O	R	R	R
$[[[+c_1+b_1]+[f_1]s_1][x_1]y_1+r_1[-r_2]:P_1=W$ or $[[[+c_1+b_1]+[f_1]s_1][x_1]y_1+r_1[-r_2]:P_1 /$ $[[[+c_2+b_2]+[f_2]s_2][x_2]y_2+r_3[-r_4]:P_3$	5.1.7	Cabling Subsystem 1 (horizontal) link	R	R	R	R

Identifier	Text Clauses	Description of Identifier	Class of administration			
			1	2	3	4
[[[+c <sub>1</sub> ]+b <sub>1</sub> ]+[f <sub>1</sub> ]s <sub>1</sub> ].[x <sub>1</sub> ]y <sub>1</sub> +r <sub>1</sub> [_r <sub>2</sub> ]:P <sub>1</sub> =XO or [[[+c <sub>2</sub> ]+b <sub>2</sub> ]+[f <sub>2</sub> ]s <sub>2</sub> ].[x <sub>2</sub> ]y <sub>2</sub> +r <sub>3</sub> [_r <sub>4</sub> ]:P <sub>2</sub>	5.1.8	Equipment outlet or telecommunications outlet	O	O	O	O
[[[+c <sub>1</sub> ]+b <sub>1</sub> ]+[f <sub>1</sub> ]s <sub>1</sub> ].[x <sub>1</sub> ]y <sub>1</sub> +r <sub>1</sub> [_r <sub>2</sub> ]:P <sub>1</sub> =XC[:P <sub>3</sub> ]	5.1.8.3	Consolidation point	O	O	O	O
[[[+c <sub>1</sub> ]+b <sub>1</sub> ]+[f <sub>1</sub> ]s <sub>1</sub> ].[x <sub>1</sub> ]y <sub>1</sub> +r <sub>1</sub> [_r <sub>2</sub> ]:P <sub>1</sub> / [[[+c <sub>2</sub> ]+b <sub>2</sub> ]+[f <sub>2</sub> ]s <sub>2</sub> ].[x <sub>2</sub> ]y <sub>2</sub> +r <sub>3</sub> [_r <sub>4</sub> ]:P <sub>3</sub> =XL[:P <sub>5</sub> ]	5.1.10	Port in ZDA in a data center	O	O	O	O
[[[+c <sub>1</sub> ]+b <sub>1</sub> ]+[f <sub>1</sub> ]s <sub>1</sub> ].[x <sub>1</sub> ]y <sub>1</sub> +r <sub>1</sub> [_r <sub>2</sub> ]:P <sub>1</sub> =XSz or [[[+c <sub>1</sub> ]+b <sub>1</sub> ]+[f <sub>1</sub> ]s <sub>1</sub> ].[x <sub>1</sub> ]y <sub>1</sub> +r <sub>1</sub> [_r <sub>2</sub> ]:P <sub>1</sub> / [[[+c <sub>2</sub> ]+b <sub>2</sub> ]+[f <sub>2</sub> ]s <sub>2</sub> ].[x <sub>2</sub> ]y <sub>2</sub> +r <sub>3</sub> [_r <sub>4</sub> ]:P <sub>3</sub> =XSz	5.1.11	Splice in Cabling Subsystem 1 link	O	O	O	O
[[+c <sub>M</sub> ]+b <sub>M</sub> ]+[f <sub>M</sub> ]s <sub>M</sub> =TMGB	5.1.12	TMGB - telecommunications main grounding busbar	R	R	R	R
[[+c <sub>T</sub> ]+b <sub>T</sub> ]+[f <sub>T</sub> ]s <sub>T</sub> =TGB[i]	5.1.13	TGB - telecommunications grounding busbar	R	R	R	R
[[[+c]+b]+[f]s].[x]y=RGB[j]	5.1.14	RGB - rack grounding busbar	O	O	O	O
[[+c]+b]+[f]s=MBN	5.1.15	mesh-BN - mesh bonding network	O	O	O	O
[[+c <sub>M</sub> ]+b <sub>M</sub> ]+[f <sub>M</sub> ]s <sub>M</sub> / [[+c <sub>E</sub> ]+b <sub>E</sub> ]+[f <sub>E</sub> ]s <sub>E</sub> =BCT	5.1.16	BCT - bonding conductor for telecommunications	R	R	R	R
[[+c <sub>M</sub> ]+b <sub>M</sub> ]+[f <sub>M</sub> ]s <sub>M</sub> =TMGB / [[+c <sub>2</sub> ]+b <sub>2</sub> ]+[f <sub>2</sub> ]s <sub>2</sub> =TGB[i <sub>2</sub> ] or [[+c <sub>1</sub> ]+b <sub>1</sub> ]+[f <sub>1</sub> ]s <sub>1</sub> =TGB[i <sub>1</sub> ] / [[+c <sub>2</sub> ]+b <sub>2</sub> ]+[f <sub>2</sub> ]s <sub>2</sub> =TGB[i <sub>2</sub> ]	5.1.17	TBB - telecommunications bonding backbone	O	R	R	R
[[+c <sub>1</sub> ]+b <sub>1</sub> ]+[f <sub>1</sub> ]s <sub>1</sub> =TGB[i <sub>1</sub> ] / [[+c <sub>2</sub> ]+b <sub>2</sub> ]+[f <sub>2</sub> ]s <sub>2</sub> =TGB[i <sub>2</sub> ]	5.1.18	GE - grounding equalizer	O	R	R	R
[[+c <sub>M</sub> ]+b <sub>M</sub> ]+[f <sub>M</sub> ]s <sub>M</sub> =TMGB / <i>object</i>	5.1.19	Bonding conductor from <i>object</i> to TMGB	O	O	O	O
[[+c <sub>T</sub> ]+b <sub>T</sub> ]+[f <sub>T</sub> ]s <sub>T</sub> =TGB[i] / <i>object</i>	5.1.20	Bonding conductor from <i>object</i> to TGB	O	O	O	O
[[+c]+b]+[f]s=MBN / <i>object</i>	5.1.21	Bonding conductor from <i>object</i> to mesh-BN	O	O	O	O
[[[+c]+b]+[f]s].[x]y=RGB[j] / <i>object</i>	5.1.22	Bonding conductor from <i>object</i> to RGB	O	O	O	O
[[+c <sub>1</sub> ]+b <sub>1</sub> ]+[f <sub>1</sub> ]s <sub>1</sub> .[x <sub>1</sub> ]y <sub>1</sub> +r <sub>1</sub> [_r <sub>2</sub> ]:P <sub>1</sub> [_P <sub>2</sub> ] / [[+c <sub>2</sub> ]+b <sub>2</sub> ]+[f <sub>2</sub> ]s <sub>2</sub> .[x <sub>2</sub> ]y <sub>2</sub> +r <sub>3</sub> [_r <sub>4</sub> ]:P <sub>3</sub> [_P <sub>4</sub> ]	6.1.1	building Cabling Subsystem 2 or 3 (backbone) cable	O	R	R	R
[[+c <sub>1</sub> ]+b <sub>1</sub> ]+[f <sub>1</sub> ]s <sub>1</sub> .[x <sub>1</sub> ]y <sub>1</sub> +r <sub>1</sub> [_r <sub>2</sub> ]:P <sub>1</sub> / [[+c <sub>2</sub> ]+b <sub>2</sub> ]+[f <sub>2</sub> ]s <sub>2</sub> .[x <sub>2</sub> ]y <sub>2</sub> +r <sub>3</sub> [_r <sub>4</sub> ]:P <sub>3</sub>	6.1.2	building Cabling Subsystem 2 or 3 pair / port	O	R	R	R
[[+c <sub>1</sub> ]+b <sub>1</sub> ]+[f <sub>1</sub> ]s <sub>1</sub> .[x <sub>1</sub> ]y <sub>1</sub> +r <sub>1</sub> [_r <sub>2</sub> ]:P <sub>1</sub> / [[+c <sub>2</sub> ]+b <sub>2</sub> ]+[f <sub>2</sub> ]s <sub>2</sub> .[x <sub>2</sub> ]y <sub>2</sub> +r <sub>3</sub> [_r <sub>4</sub> ]:P <sub>3</sub> =XSz(g)	6.1.3	building Cabling Subsystem 2 or 3 cable splice	O	O	O	O
[[+c <sub>1</sub> ]+b <sub>1</sub> ]+[f <sub>1</sub> ]s <sub>1</sub> / [[+c <sub>2</sub> ]+b <sub>2</sub> ]+[f <sub>2</sub> ]s <sub>2</sub> =U(n(d))=F(m)	6.1.4	firestop location	O	R	R	R
+c	7.1.1	campus or site	O	O	O	R
[+c]+b	7.1.2	building	O	O	R	R
[+c <sub>1</sub> ]+b <sub>1</sub> +[f <sub>1</sub> ]s <sub>1</sub> .[x <sub>1</sub> ]y <sub>1</sub> +r <sub>1</sub> [_r <sub>2</sub> ]:P <sub>1</sub> [_P <sub>2</sub> ] / [+c <sub>2</sub> ]+b <sub>2</sub> +f <sub>2</sub> ]s <sub>2</sub> .[x <sub>2</sub> ]y <sub>2</sub> +r <sub>3</sub> [_r <sub>4</sub> ]:P <sub>3</sub> [_P <sub>4</sub> ]	7.1.3	Inter-building cable	O	O	R	R
[+c <sub>1</sub> ]+b <sub>1</sub> +[f <sub>1</sub> ]s <sub>1</sub> .[x <sub>1</sub> ]y <sub>1</sub> +r <sub>1</sub> [_r <sub>2</sub> ]:P <sub>1</sub> / [+c <sub>2</sub> ]+b <sub>2</sub> +f <sub>2</sub> ]s <sub>2</sub> .[x <sub>2</sub> ]y <sub>2</sub> +r <sub>3</sub> [_r <sub>4</sub> ]:P <sub>3</sub>	7.1.4	Inter-building cable pair / port	O	O	R	R
[+c <sub>1</sub> ]+b <sub>1</sub> +[f <sub>1</sub> ]s <sub>1</sub> .[x <sub>1</sub> ]y <sub>1</sub> +r <sub>1</sub> [_r <sub>2</sub> ]:P <sub>1</sub> / [+c <sub>2</sub> ]+b <sub>2</sub> +f <sub>2</sub> ]s <sub>2</sub> .[x <sub>2</sub> ]y <sub>2</sub> +r <sub>3</sub> [_r <sub>4</sub> ]:P <sub>3</sub> =XSz(g)	7.1.5	Inter-building cable splice	O	O	O	O

Identifier	Text Clauses	Description of Identifier	Class of administration			
			1	2	3	4
$[+c]+T(g)$	9.3	Outdoor telecommunications space (e.g., maintenance holes, handholes, pedestals, outdoor cabinets).	O	O	O	O
$\frac{[[[+c_1]+b_1]+[f_1]s_1][x_1]y_1 / [[+c_1]+b_1]+[f_1]s_1][x_2]y_2=U(n(d))}{[[+c_1]+b_1]+[f_1]s_1 / [[+c_1]+b_1]+[f_2]s_2=U(n(d))}$	9.4.1	intra-space pathway	O	O	O	O
$[[+c_1]+b_1]+[f_1]s_1 / [[+c_1]+b_1]+[f_2]s_2=U(n(d))$	9.4.2	building pathway	O	O	O	O
$[+c_1]+b_1+[f_1]s_1=U(n(d))$	9.4.3	building entrance pathway	O	O	O	O
$[+c_1]+b_1+[f_1]s_1 / [+c_2]+b_2+[f_2]s_2=U(n(d))$	9.4.4	outside plant pathway Outdoor telecommunications space Identifier $[+c]+T(g)$ may be used in place of building identifier $[+c]+b+[f]s$	O	O	O	O
$+c+T(g)=U(n(d))$	9.4.5	campus entrance pathway	O	O	O	O
$\frac{[[[+c_1]+b_1]+[f_1]s_1][x_1]y_1+r_1[_r_2]:P_1 \setminus [[+c_2]+b_2]+[f_2]s_2][x_2]y_2+r_3[_r_4]:P_3}{[[[+c_1]+b_1]+[f_1]s_1][x_1]y_1+r_1[_r_2]:P_1 \setminus [[+c_2]+b_2]+[f_2]s_2][x_2]y_2-e_2-s_2:P_2}$	A.1	patch cord	O	O	O	O
$\frac{[[[+c_1]+b_1]+[f_1]s_1][x_1]y_1+r_1[_r_2]:P_1 \setminus [[+c_2]+b_2]+[f_2]s_2][x_2]y_2-e_2-s_2:P_2}{[[[+c_1]+b_1]+[f_1]s_1][x_1]y_1-e_1-s_1:P_1 \setminus [[+c_2]+b_2]+[f_2]s_2][x_2]y_2-e_2-s_2:P_2}$	A.2	equipment cord	O	O	O	O
$\frac{[[[+c_1]+b_1]+[f_1]s_1][x_1]y_1-e_1-s_1:P_1 \setminus [[+c_2]+b_2]+[f_2]s_2][x_2]y_2-e_2-s_2:P_2}{[[[+c_1]+b_1]+[f_1]s_1][x_1]y_1-e_1-s_1:P_1 \setminus [[+c_2]+b_2]+[f_2]s_2][x_2]y_2-e_2-s_2:P_2}$	A.3	direct cable between equipment	O	O	O	O

The following notes apply for both table 1 and table 2.

#### NOTES:

1. R = required identifier for class, when corresponding element is present.  
O = optional identifier for class.
2. Variables are in italics.
3. Square brackets “[” and “]” indicate optional fields that may not be present depending on the class of administration or the location of the component being identified.
4. The equal sign “=” is used to specify a functional aspect of an object.
5. The period “.” character separates the portion of the identifier for the space from the portion of the identifier for the cabinet or frame.
6. The colon “:” is used as a prefix to port identifiers.
7. The underscore “\_” character separates the vertical and horizontal coordinates of a patch panel in a cabinet, frame, or wall section.
8. The forward slash “/” is used between the identifiers of the two ends of a Cabling Subsystem 1, 2, or 3 cable, or telecommunications pathway.
9. The back slash “\” is used between the identifiers of the two ends of a patch cord or jumper.
10. The hyphen “-” is used in the TIA-606-A compatible identifiers as a delimiter between portions of the identifier and in the ISO/IEC compatible identifiers to prefix portions of equipment identifiers (e.g., switch name and switch port).
11. Parentheses “()” are used to provide additional information, such as the coordinates of a maintenance hole, conduit number within a duct bank, or subduct number within a conduit.



12. For ISO/IEC TR 14763-2-1 compatible identifiers, the plus sign “+” is part of the identifier and specifies that the next portion of the identifier is the location aspect of an object.

#### **4.6 Alternative label formats**

Labels may optionally be a cross reference that provides a direct link to the identifier within the record in the administration system. This link may be a non-machine readable label with a numeric code or a machine readable code such as a RFID or bar code.

Machine readable and non-machine readable labels shall be located so that each label can be read uniquely.

## 5 CLASS 1 ADMINISTRATION

Class 1 addresses the administration needs when only one equipment room (ER) is administered. This ER is the only telecommunications space (TS) administered. Neither TRs, Cabling Subsystem 2 or 3 (backbone) cabling, or outside plant cabling is administered.

### 5.1 Infrastructure identifiers

The following infrastructure identifiers shall be required in class 1 administration, when the corresponding elements are present:

- a) TS identifier
- b) cabinet, rack, enclosure, wall segment identifier
- c) patch panel or termination block identifier
- d) Patch panel port and termination block position identifiers
- e) identifiers for cables between cabinets, racks, enclosures, or walls in the same space
- f) Cabling Subsystem 1 (horizontal) link identifier
- g) Telecommunications main grounding busbar (TMGB) identifier
- h) Telecommunications grounding busbar (TGB) identifier

In the case of a tenant with single-ER infrastructure, in a multi-tenant building, the TMGB will commonly be elsewhere in the building, and the single grounding busbar in the tenant's ER will be a TGB.

Additional information may be enclosed by parentheses after the end of the required format of an identifier.

#### 5.1.1 Telecommunications space identifier

A telecommunications space (TS) identifier, unique within the building, shall be assigned to the TS.

##### 5.1.1.1 TIA-606-A compatible format

The TIA-606-A compatible format of the TS identifier is:

*fs*

where:

*f* = numeric character(s) identifying the floor of the building occupied by the TS. This portion of the identifier is optional for buildings with only a single floor.

*s* = alpha character(s) uniquely identifying the TS or computer room on floor *f*.

For buildings with non-numeric floors, alphanumeric characters may be used in the "*f*" format and shall be consistent with the floor naming convention used within the building.

All TS identifiers in a single infrastructure should have the same format where possible.

##### 5.1.1.2 ISO/IEC compatible format

The TS identifier format compatible with ISO/IEC TR 14763-2-1 is:

*+fs*

This is the same as the TIA-606-A compatible format, but with the leading '+' to indicate that it is a location aspect.

### 5.1.1.3 Implementation and labeling

Examples of TS identifiers using the TIA-606-A compatible format are:

3TR	for Telecom Room on the 3rd floor
405	for room 405

Examples of TS identifiers using the ISO/IEC TR 14763-2-1 compatible format are:

+3TR	for Telecom Room on the 3rd floor
+405	for room 405

The TS shall be labeled with the TS identifier inside the room so as to be visible to someone working in that room. The labels do not need to include the '+' sign.

## 5.1.2 Cabinet and rack identifiers

### 5.1.2.1 Grid coordinates

In telecommunications spaces with multiple rows of cabinets or racks, such as computer rooms and equipment rooms, a grid coordinate system should be used in identifying the equipment cabinets and racks located within the room. See 5.1.2.4 for alternative guidelines to a grid system.

In rooms that have access floor systems, identification for the space shall use the access floor grid identification scheme described in this clause. In rooms without access floor, the ceiling tile grid, if present, should be used as the basis for location identification. If the room has neither a floor tile grid nor ceiling tile grid, a grid should be applied to the floor plan. The grid should be dense enough to ensure that two cabinets do not occupy the same grid coordinates – consider grid spacing between 500 mm and 600 mm (20 in to 24 in).

The quantity of characters used along the “X” and “Y” axes shall be adequate to cover the entire space to be covered by the grid.

The “X” and “Y” axes may be reversed to minimize the quantity of characters required – consider selecting the long axis of the room as the “X” axis and the short axis of the room as the “Y” axis.

The starting point for the grid may be any one of the four corners of the space to be covered. When selecting the starting point, consider the direction in which the room might be expanded. The starting point of the grid should be in a corner of the room away from any likely direction of room expansion.

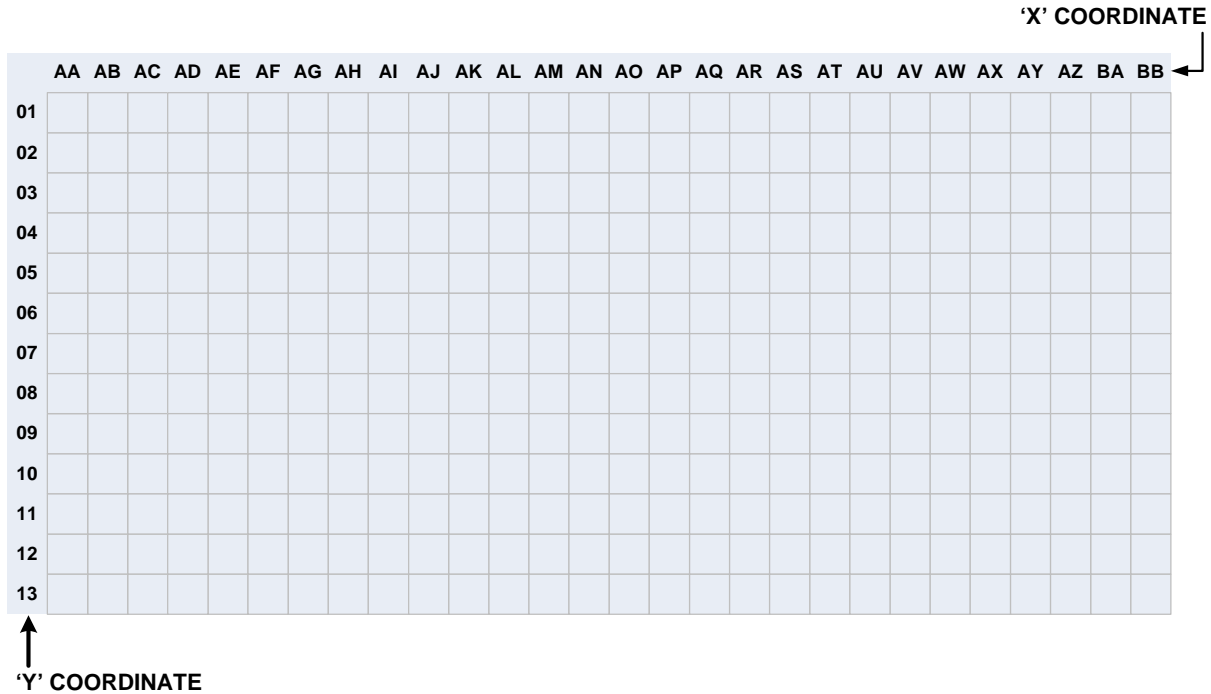

**Figure 4 – Example of room grid coordinates**

It is recommended that grid coordinate markings be placed on walls. Text on labels should be a font without serifs, upper case and large enough to easily be read at a distance. Floor tiles or ceiling tiles (if they are used as the basis of the grid) may also be marked.

### 5.1.2.2 Specification of location identifier where grid coordinates are available

#### 5.1.2.2.1 TIA-606-A compatible format

The grid coordinate location TIA-606-A compatible identifier shall have a format of

*fs.xy*

where:

- fs* telecommunications space or computer room identifier as defined in 5.1.1. This portion of the identifier is optional for a class 1 administration system limited to a single equipment room or an administration system limited to a single computer room.
- x* one or more alphabetic characters designating the "X" coordinate of the rack or cabinet. The quantity of characters used for the "X" coordinate shall be the same throughout the entire space covered by the grid. Thus, as shown in figure 4, a space that requires between 27 and 676 coordinates along the "X" axis shall start the X-axis sequence at "AA" rather than "A." The number 676 represents the quantity of coordinates between AA and ZZ.
- y* one or more numeric characters designating the "Y" coordinate of the rack or cabinet. The quantity of digits used for the "Y" coordinate shall be the same throughout the entire space covered by the grid. Thus, as shown in figure 4, a space that requires more than 9 but fewer than 100 coordinates along the "Y" axis shall start at "00" or "01" rather than "0" or "1".

### 5.1.2.2.2 ISO/IEC compatible format

The grid coordinate location format compatible with ISO/IEC TR 14763-2-1 is:

+fs.xy

### 5.1.2.3 Implementation where grid coordinates are available

For rooms using the grid system, it is possible that cabinets and racks will occupy more than one grid location. In this case, the same location shall be used on every cabinet or rack to determine the grid location. This location may be the corner closest to the starting point of the grid, the left front corner, right front corner, or front centre as long as the same location is used throughout the room. Following this convention allows for cabinets and frames to be substituted or replaced with different sized items without the need to modify the identification of existing cabinets or frames.

In figure 5, the location on the floor space grid where the right front corner of the cabinet is located determines its identifier. Thus, the cabinet whose right front corner is on tile AD02 has the identifier AD02.

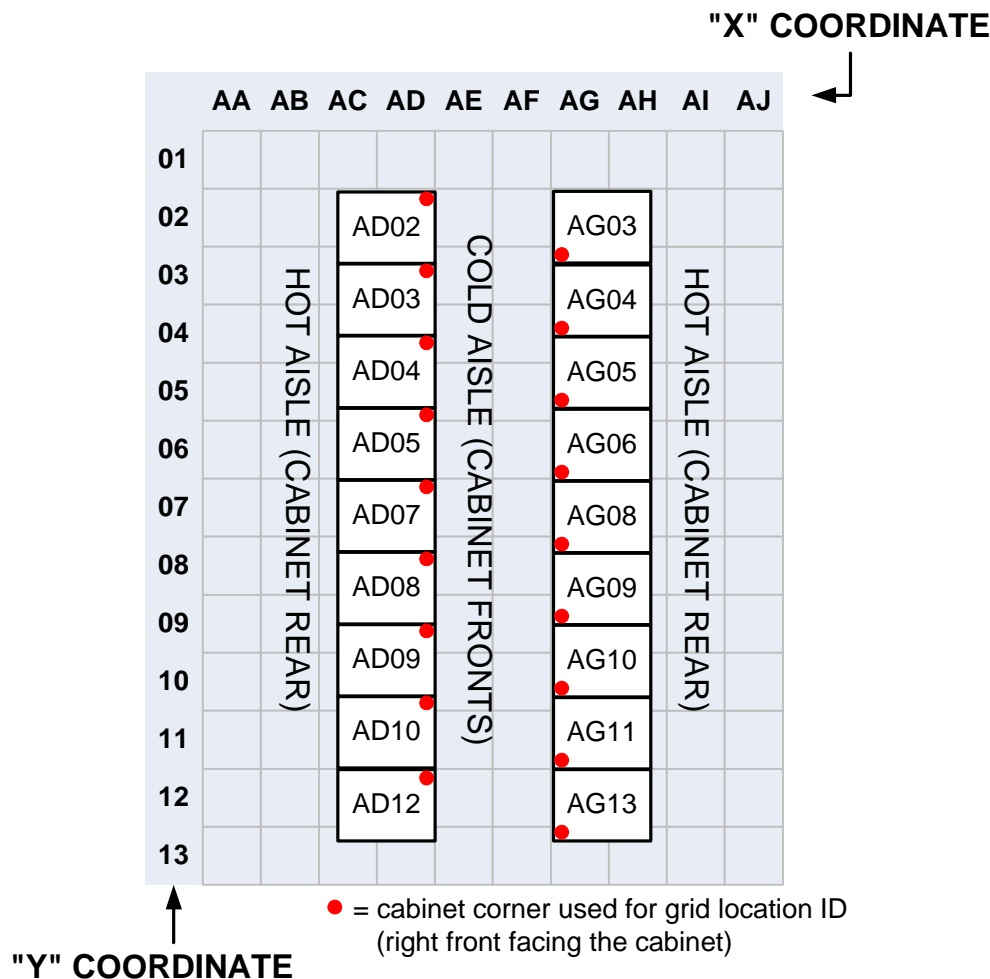

**Figure 5 – Example of cabinet identifiers using grid**

Wall-mounted systems in rooms using grids shall use the grid coordinates of the wall space. The wall space should be divided into sections the width of each grid coordinate. Thus, a wall-mounted rack above tile AJ01 would have the identifier AJ01.

The grid coordinate system may be used to identify enclosures under access floors or in overhead spaces in rooms that have grid coordinates.

#### **5.1.2.4 Specification of location identifier where grid coordinates are not used**

In rooms without grid coordinates, cabinets and racks may be identified by their row number and location within the row. This method is only recommended in spaces that meet the following criteria:

- small number of cabinets or frames in a few rows

or

- uniformly spaced or static equipment rows – rows that will not be reoriented or replaced with more or fewer rows of equipment

and

- uniform width cabinets, racks, and frames that will not be replaced with those of different width.

The quantity of characters used shall be the same throughout the space.

##### **5.1.2.4.1 TIA-606-A compatible format**

Where grid coordinates are not available, a TIA-606-A compatible location identifier shall have a format of:

*fs.xy*

where:

- fs* telecommunications space or computer room identifier as defined in 5.1.1. This portion of the identifier is optional for a class 1 administration system limited to a single equipment room or an administration system limited to a single computer room.
- x* one or more characters designating the cabinet's or frame's row identifier. The quantity of characters used for the row identifier should be the same throughout the entire space. This character is optional if there is only one row in the telecommunication space. If there are more than nine rows, It is recommended these characters be alphabetic instead of numeric.
- y* one or more characters designating the cabinet's or frame's location within the row. The quantity of characters used should be the same throughout the entire space. The location identifiers within a row should be consistent between rows, with numbers starting from the same end and increasing in the same direction.

##### **5.1.2.4.2 ISO/IEC compatible format**

The non-grid location identifier format compatible with ISO/IEC TR 14763-2-1 is:

*+fs.xy*

### 5.1.2.5 Implementation of location identifier where grid coordinates are not used

Figure 6 provides an example of cabinet and rack location identifiers using the non-grid scheme (row/position method) described in this clause.

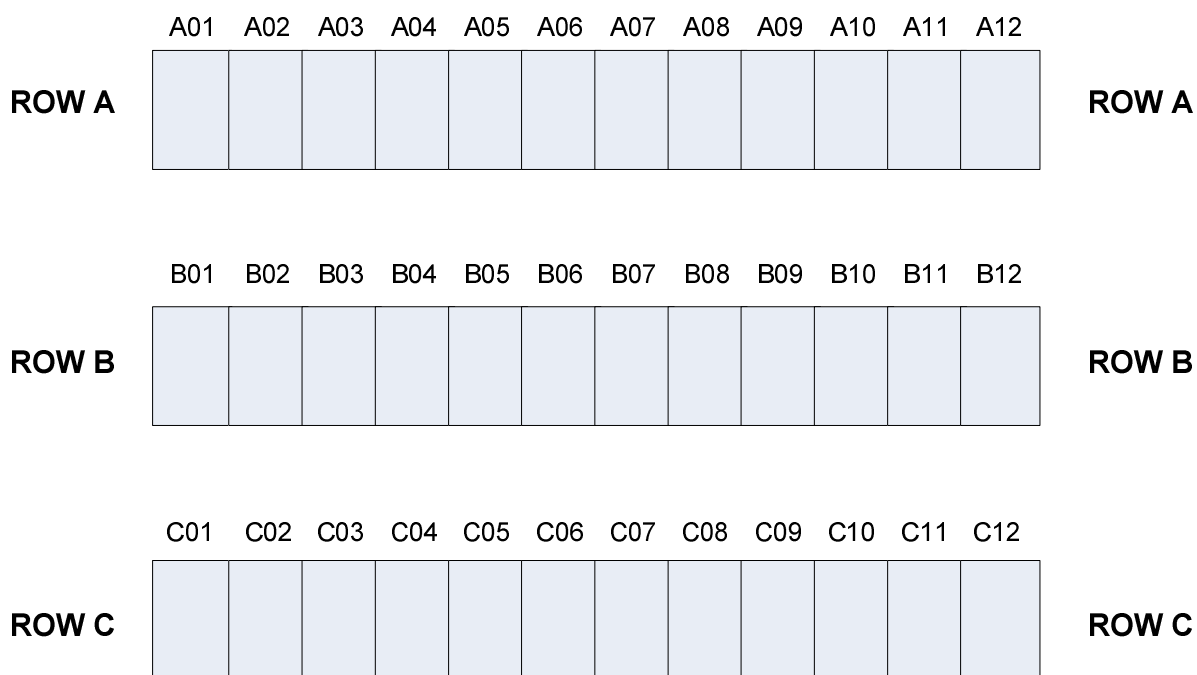

**Figure 6 – Example of non-grid coordinates**

Each row should be labeled with its row identifier at both ends of the row. Row position identifiers should be sequential, shall be unique, and shall use the same format for all rows within a room.

Wall spaces in rooms that do not use grids should have identifiers for each wall on which telecommunications equipment is mounted. The wall space should be divided into sections (corresponding to frame or cabinet numbers); the sections may either be the width of a typical cabinet or frame, or be the distance from the left edge of the wall in meters (rounded up to the nearest integer). See figure 7.

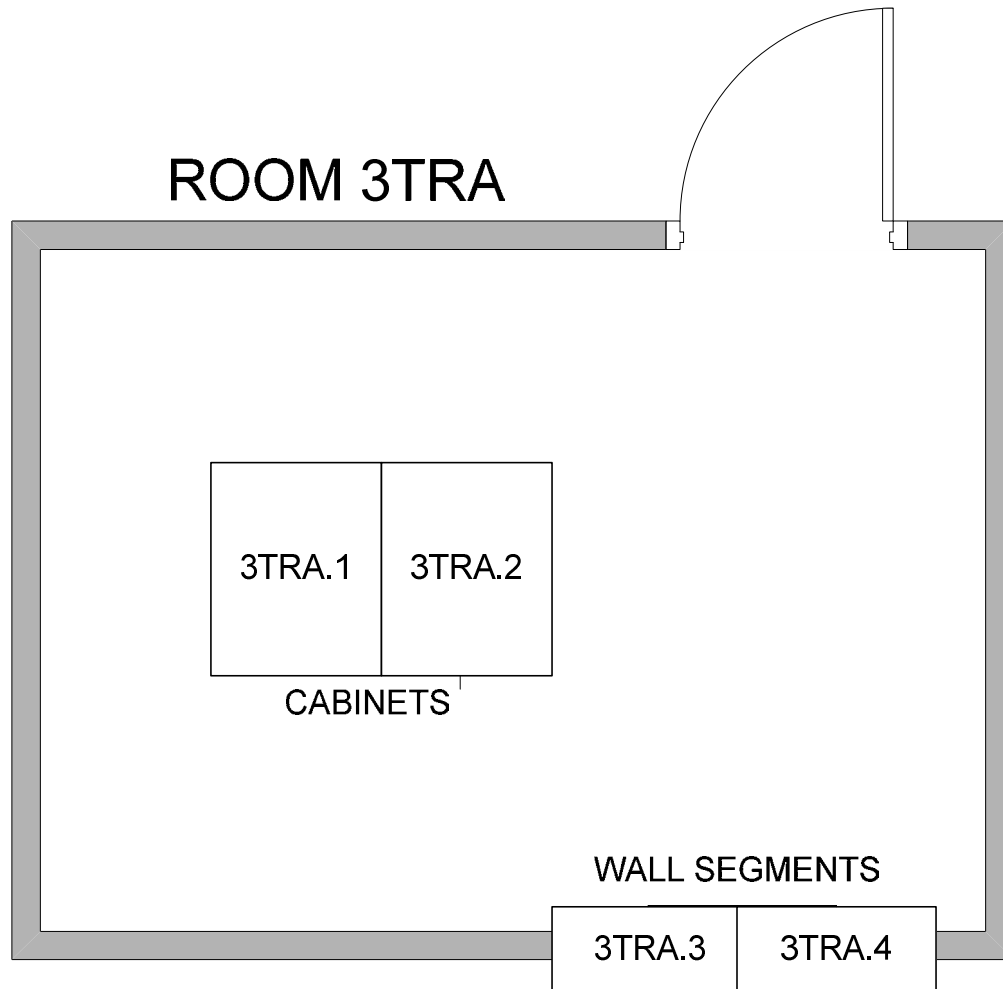

**Figure 7 – Example of telecommunications room cabinet and wall segment identifiers**

For example, Telecom Room A on the 3<sup>rd</sup> floor (3TRA) shown in figure 7 above has two cabinets and two wall segments, and thus does not require a grid identification scheme. The two cabinets could be named:

3TRA.1 and 3TRA.2

The wall space used for wall-mounted patch panels is the width of two cabinets. The wall segments could be named:

3TRA.3 and 3TRA.4

#### **5.1.2.6 Cabinet and rack labeling**

Each cabinet and rack shall be labeled on the front and rear in plain view with its coordinates from its location identifier. Preferred locations for labels are the top and bottom on a permanent part of the cabinet or rack as shown in figure 8. Text on labels should be a font without serifs, upper case, and large enough to be easily read while standing near the cabinet or rack. Text on labels shall be machine printed, and the label color shall contrast with the background upon which they are affixed (e.g., white on a dark surface, black on a light background).



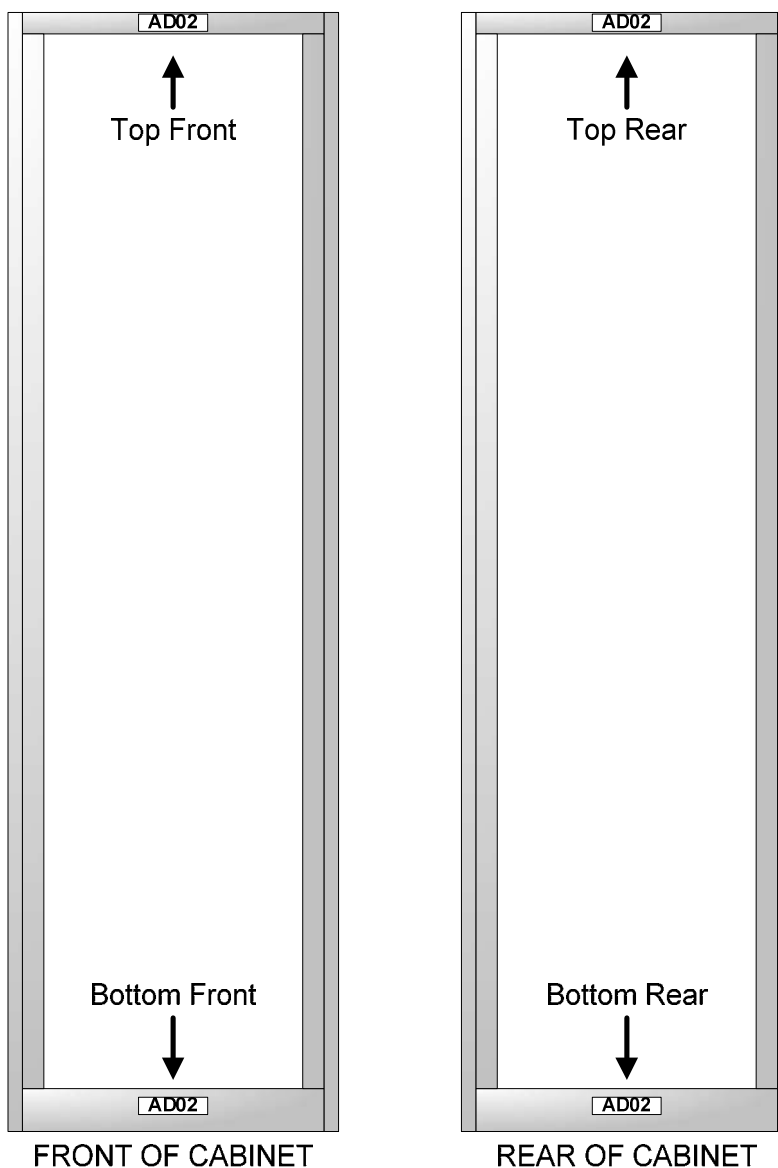

**Figure 8 – Sample rack and cabinet labeling**

### 5.1.3 Patch panel and termination block identifier

#### 5.1.3.1 Rack- or cabinet-mounted patch panel identifiers

##### 5.1.3.1.1 TIA-606-A compatible format

In TIA-606-A compatible systems, patch panels mounted in cabinets and racks in a single vertical column shall have identifiers with the following format:

$$fs.x_1y_1-r_1$$

where:

$fs.x_1y_1$  is the cabinet, rack, frame, or wall segment identifier as defined in 5.1.2.

The permitted formats for  $r_1$  are:

- $r_1$  two numerical digits designating the location of the top of the patch panel in EIA/ECA-310-E / IEC 60297-3-100 rack units (U) from the bottom of the usable space in the cabinet or frame. This is the recommended format. See figure 9 for an example of sequential patch panel designation.
- $r_1$  one letter indicating the side of the cabinet or frame followed by two numerical digits designating the location of the top of the patch panel in rack units from the bottom of the usable space in the cabinet or frame. The letter indicating the side may be any set of unique letters consistently used within the infrastructure – for example:
- A, B, C, D for the four sides of a cabinet starting from the front and proceeding clockwise (when viewed from the top)
  - N, S, E, W for the four sides of the cabinet (if the sides are aligned with the four compass directions)
  - F, R if only the front and rear of cabinets and frames are used.
- $r_1$  one to two characters designating the patch panel location within the cabinet or rack beginning at the top. Horizontal cable managers are not included when sequencing patch panels. The quantity of characters used shall be the same for all patch panels in the cabinet or rack. If  $r_1$  uses a mixture of alphabetical and numeric characters, the letters “I,” “O,” and “Q” shall be excluded.

#### 5.1.3.1.2 ISO/IEC compatible format

The patch panel identifier format compatible with ISO/IEC TR 14763-2-1 is:

$+fs.x_1y_1+r_1$

#### 5.1.3.1.3 Implementation and labeling

##### 5.1.3.1.3.1 General

Patch panels shall be labeled with their identifiers (e.g.,  $fs.x_1y_1-r_1$ ).

For brevity, the building and room name is typically not included on the labels for cabinets, racks, and equipment mounted in them.

Using cabinet and racks with rails marked with rack unit positions aids in the identification and placement of patch panels.

The patch panels should also be labeled with the identifier of the patch panels at the far-end of the cables, if practicable. Each port, the first port, or the last of each subpanel shall be labeled.

In the example below in figure 9 the third patch panel in cabinet AD02 in room 1DC that is 35U from the bottom of the usable space in the cabinet would be named:

1DC.AD02-35

Although the patch panels occupy multiple rack unit positions, each patch panel is identified by the rack unit position of the top of the patch panel.

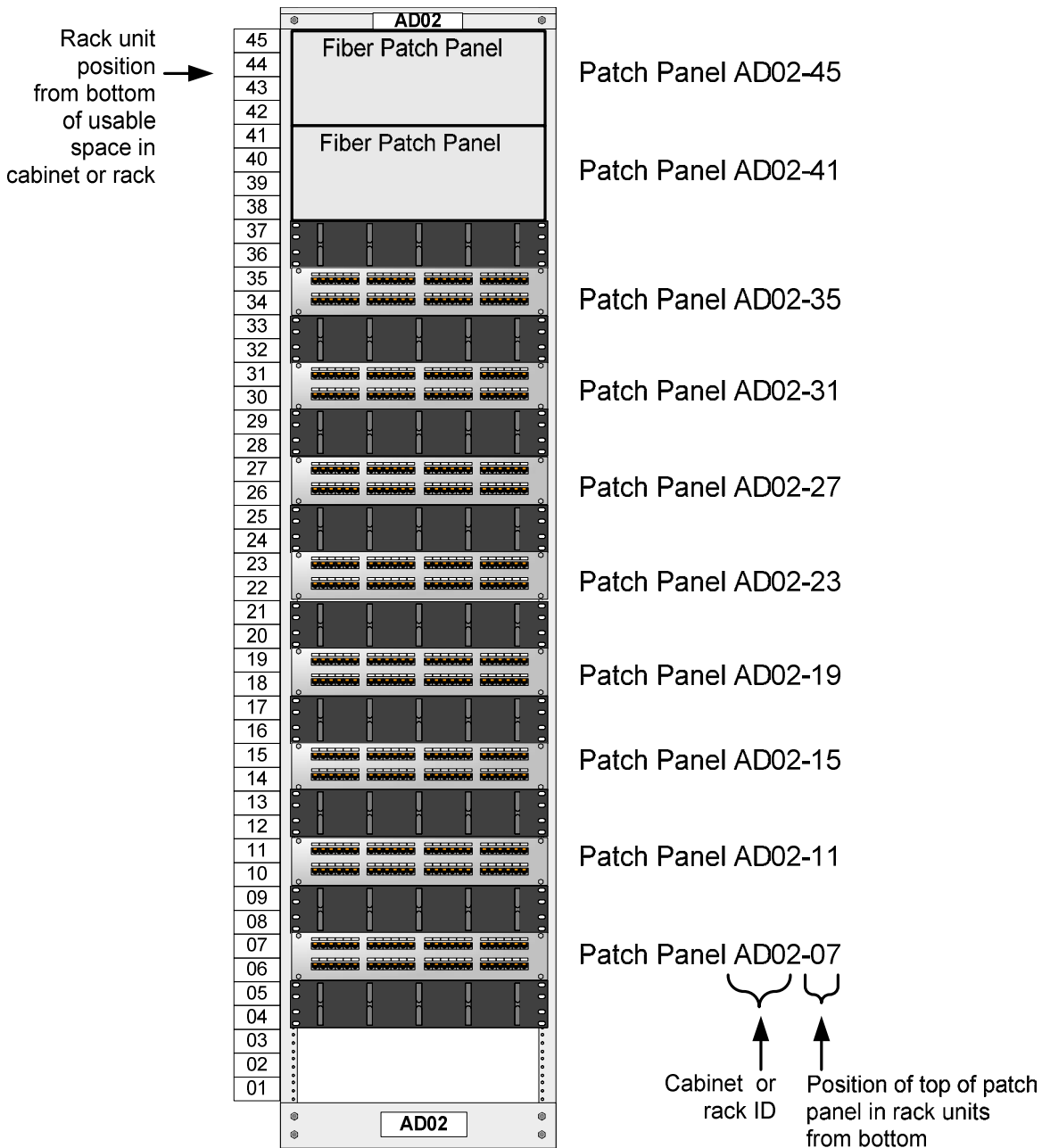

Figure 9 – Example of vertically aligned patch panel identification

Where space permits, patch panel should also have labels to specify the identifiers of the far-end ports using the format:

$[f_1s_1.][x_1y_1-r_1]$  Ports  $PN_1$  to  $[f_2s_2.][x_2y_2-r_2]$  Ports  $PN_2$

Where  $f_1s_1.x_1y_1-r_1$  and  $f_2s_2.x_2y_2-r_2$  are the patch panel identifiers as defined in 5.1.3.1.

*Ports* either “p” or the entire word “ports” as space permits;  
*PN<sub>1</sub>* port number range at the near-end patch panel;  
*PN<sub>2</sub>* port number range at the far-end patch panel.

The same label in an ISO/IEC TR 14763-2-1 compatible format is:

$[+f_1s_1.][x_1y_1+r_1]$  Ports  $PN_1$  to  $[+f_2s_2.][x_2y_2+r_2]$  Ports  $PN_2$

The near end room name  $f_1s_1$  and near-end patch panel identifier  $x_1y_1-r_1$  can be omitted since this information is implicit and inferred from the required cabinet/rack and patch panel labels.

The far end room name may also be omitted if the far-end patch panel is within the same room.

If space is available, the ports on the patch panel should also be labeled. See figure 10, figure 12, and figure 13 for examples.

Patch panels that support Cabling Subsystem 2 or 3 cabling should indicate the name of the space (e.g., MDA, IDA, HDA, TR) to which the cables run.

The patch panel label text shall be machine printed, be conspicuous, and large enough to be legible. Text may be a mix of upper and lower case, and should use a font without serifs.

Where cables are diversely routed between patch panels, label colors or other form of identification shall be used to reflect cable route diversity.

Different colors may also be used for labels, twisted pair cables, modular jacks, and twisted pair patch cables to indicate different applications (e.g., production, test, development, Internet), function (e.g., backbone or horizontal), or destination (e.g., different TRs, MDAs, IDAs or HDAs).

Use manufacturer provided labels and mounting surfaces wherever possible.

#### 5.1.3.1.3.2 Balanced twisted-pair patch panels

Figure 10 shows a 48-port balanced twisted-pair patch panel at 35U from the bottom of cabinet AD02, with identifier AD02-35 with:

- 12 UTP cables to the patch panel 35U from the bottom of cabinet AG03, ports 01-12,
- 12 UTP cables to the patch panel 31U from the bottom of cabinet AG04, ports 01-12,
- 12 UTP cables to the patch panel 45U from the bottom of cabinet AG05, ports 01-12,
- 12 UTP cables to the patch panel 42U from the bottom of cabinet AG06, ports 01-12.

In figure 10, the labels below each group of six ports includes the local and far-end patch panel and port identifiers.

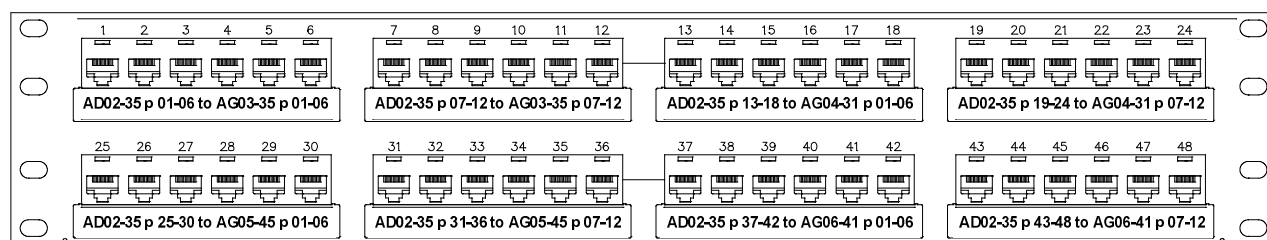

**Figure 10 – Labeling example for UTP patch panel with label fields**

Figure 11 provides an example of labeling for a UTP patch panel that does not have a manufacturer-provided label field for the patch panel identifier.

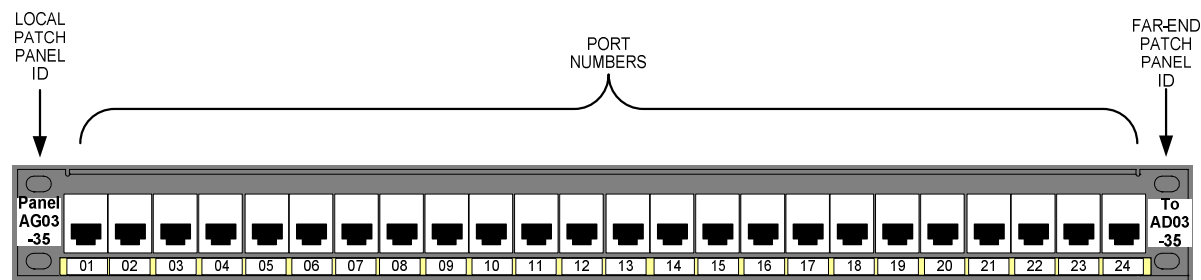

**Figure 11 – Labeling example for UTP patch panel without patch panel ID label fields**

### 5.1.3.1.3.3 Optical fiber patch panels

Figure 12 and figure 13 show two ways of labeling a patch panel using or ignoring subpanels. In figure 12, the patch panel has subpanels, but they are ignored for purposes of numbering ports.

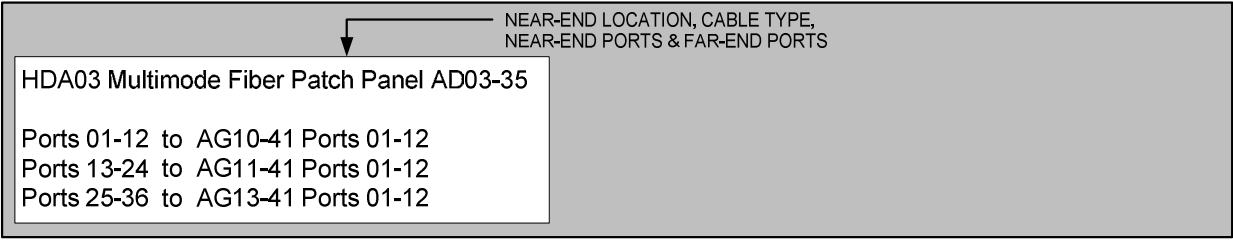
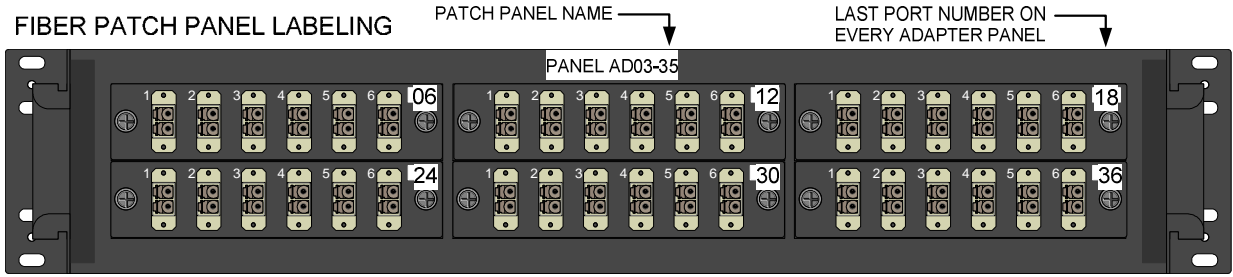

FIBER PATCH PANEL COVER LABELING

**Figure 12 – Labeling example of a fiber patch panel ignoring subpanels**

In figure 13 port identifiers include the subpanel name. The patch panel illustrated in both figure 12 and figure 13 is the patch panel 35U from the bottom of cabinet AD03 (patch panel AD03-35). It has 24 multimode fibers (12 pairs of multimode fibers) each to:

- patch panel AG10-41 ports 01-12,
- patch panel AG11-41 ports 01-12,
- patch panel AG13-41 ports 01-12.

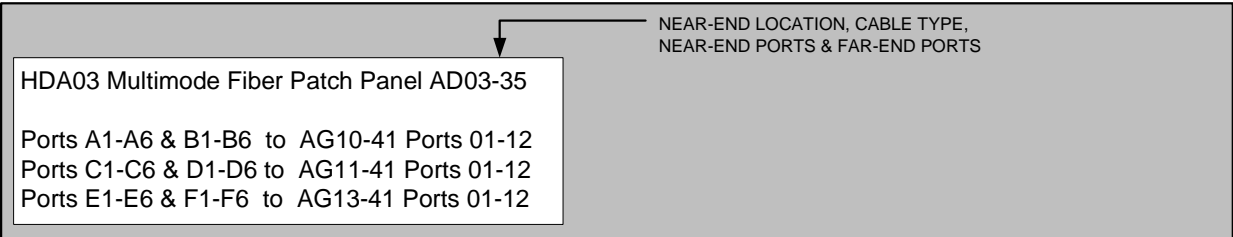
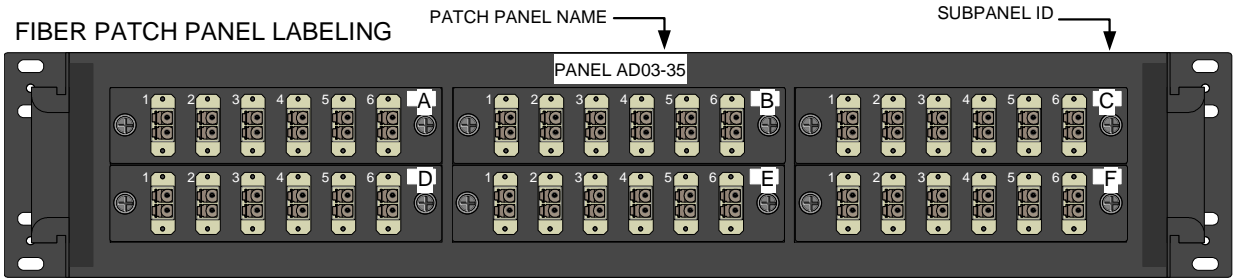

FIBER PATCH PANEL COVER LABELING

**Figure 13 – Labeling example of a fiber patch panel with subpanels**

Patch panel labels may include additional information such as cable type, near-end telecommunications space name, and far-end telecommunications space name (e.g., TR, MDA or HDA name). See figure 14 for a patch panel label including this additional information. The first line on the cover label identifies that the patch panel is located in the MDA, that it terminates single-mode fiber, and that the patch panel ID is CZ54-45. The second through fourth lines of the cover label specify the patch panel IDs to which the cables on each port terminate. The second through fourth lines also specify the HDAs in which each of the far-end patch panels are located.

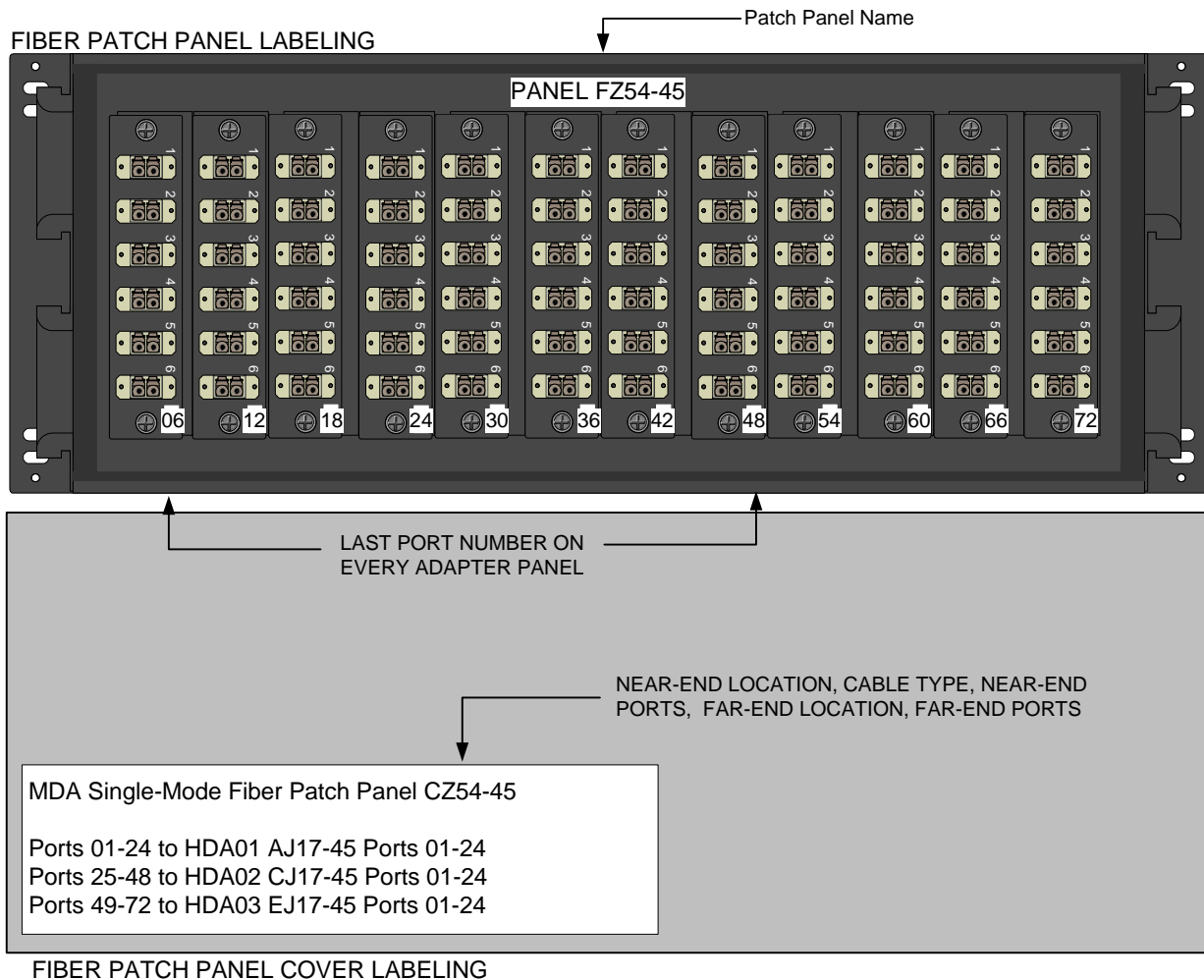

**Figure 14 – Labeling example of a fiber patch panel with optional MDA and HDA identifiers**

### 5.1.3.2 Frame- or wall-mounted termination block or patch panel identifiers

#### 5.1.3.2.1 TIA-606-A compatible format

Termination blocks or patch panels mounted where they are not in a single vertical column, such as on frames or walls, shall be identified using the following format in TIA-606-A compatible systems:

$$fs.x_1y_1-r_1-r_2$$

where:

- $r_1$  one to three characters designating the vertical termination block or patch panel location, within frame or wall section. The characters may be sequence numbers or numeric digits indicating vertical distance of the top left of the patch panel from the bottom left of the cabinet, frame, or wall section in cm.
- $r_2$  one to two characters designating the horizontal termination block or patch panel location, within frame or wall section. The characters may be sequence numbers or numeric digits indicating horizontal distance of the top left of the patch panel from the bottom left of the cabinet, frame, or wall section in cm.

Note that the underscore “\_” character separates the vertical and horizontal coordinates. See figure 15 for an example of identifiers termination blocks that are mounted on a wall section.

#### 5.1.3.2.2 ISO/IEC compatible format

The patch panel or terminal block identifier format compatible with ISO/IEC TR 14763-2-1 is:

$$+fs.x_1y_1+r_1-r_2$$

#### 5.1.3.2.3 Implementation

See figure 15 for an example using wall mounted termination blocks. The wall segment is named TRA.3 and is from the example above in figure 7 (a wall section in telecom room 3TRA). Each termination block is identified by the location of its top left corner from the bottom left of the wall section in cm.





**Figure 15 – Example of non-vertically aligned patch panel identification**

## 5.1.4 Patch panel port and termination block position identifiers

### 5.1.4.1 TIA-606-A compatible format

The following format shall be used to identify patch panel ports and termination block IDC connectors in TIA-606-A compatible systems. The colon “:” is used between the characters designating the patch panel/termination block and the characters designating the port:

$$f_1s_1.x_1y_1-r_1:P_1$$

where:

$f_1s_1.x_1y_1-r_1$  is the patch panel or termination block identifier as specified in 5.1.3.

$P_1$  One to three characters designating the port on the patch panel or termination position on the termination block.

For patch panels that do not include subpanels or for patch panels whose ports will be labeled in sequence, ignoring the presence of subpanels this field is a single number:

$P_1$  one to three numeric characters corresponding to the port/termination position.

The quantity of digits used for port/termination position identifiers shall be the same for all ports or terminations on the patch panels. Thus, the first port on a 24-port patch panel should be “01” and the first port on a 144-port patch panel should be “001”.

For patch panels that include subpanels:

$P_1$   $pn$ ,

where:

$p$  1 to 2 alphabetic characters that identifies the subpanel located within the patch panel starting sequentially from “A” and excluding “I”, “O”, and “Q”.

$n$  one or two numeric characters corresponding to the port number within the subpanel. The quantity of digits used for port identifiers shall be the same for all ports on the patch panel. Thus, the first port on a subpanel with 12-ports should be “01” instead of “1”.

This identifier format shall also be used for telecommunications outlets terminated in cabinets, frames, and wall segments within a distributor, telecommunications room, or data center.

### 5.1.4.2 ISO/IEC compatible format

The ISO/IEC TR 14763-2-1 compatible identifier format for patch panel ports and termination block IDC connectors is:

$$+f_1s_1.x_1y_1+r_1:P_1$$

### 5.1.4.3 Implementation

In most cases, the port identifier is the sequential port number on the patch panel. So the 3<sup>rd</sup> port on patch panel AD02-35 would have the identifier:

AD02-35:03

In fiber patch panels that use subpanels, the port name would include the subpanel name and port number. Thus, the 1<sup>st</sup> port on subpanel D (4<sup>th</sup> subpanel) in fiber patch panel AD02-41 would be:

AD02-41:D01

#### 5.1.4.4 Labeling

All ports on patch panels and all positions on termination blocks shall be labeled with the corresponding port number or position number and optionally with additional identifier fields as practicable.

All subpanels shall be labeled with their subpanel identifier.

See the examples above in clauses 5.1.3.1.3.2 and 5.1.3.1.3.3.

Certain applications may provide electrical power in addition to data transmission over balanced twisted-pair cables. Visual segregation and identification of ports with power may be accomplished through the use of the symbol in figure 16.



**Figure 16 – Optional symbol to indicate powered port or outlet**

In a single-dwelling residence, it is recommended to include the room and wall location of each outlet on the patch panel if the outlets are not labeled. For example, B1-N could denote an outlet on the north wall of bed room one. If single-dwelling residential outlets are not labeled then consideration should be given to inclusion of simple floor plans at the distribution device that provide a graphic correlation between physical outlet locations and outlet designations.

#### 5.1.5 Cables between patch panels or termination blocks

Cables terminated on patch panels or termination blocks shall be identified by the identifiers of the ports/terminations on both ends of the cable separated by a forward slash. If the cable supports multiple ports/termination positions, then the first and last port/termination on each end of the cable should be provided in the identifier.

##### 5.1.5.1 TIA-606-A compatible format

The TIA-606-A compatible format of these identifiers shall be:

$$f_1s_1.x_1y_1-r_1:P_1[-P_2] / f_2s_2.x_2y_2-r_2:P_3[-P_4]$$

where:

$f_1s_1.x_1y_1-r_1:P_1$  and  $f_2s_2.x_2y_2-r_2:P_3$  are the port identifiers for the first port of the patch panels or termination blocks on the two ends of the cable as defined in 5.1.4. If the cable terminates on multiple ports, the last ports at the two ends of the cable are identified using the  $P_2$  and  $P_4$  identifiers.

The termination closest to the main cross-connect in the telecommunications cabling system hierarchy shall be listed first (before the forward slash). If the terminations are equal within the cabling system hierarchy, then the termination with the lesser alphanumeric identifier shall be listed first.

### 5.1.5.2 ISO/IEC compatible format

The ISO/IEC TR 14763-2-1 compatible identifier format for cables terminated on both ends on patch panels or termination blocks is:

$$+f_1s_1.x_1y_1+r_1:P_1[_P_2] / +f_2s_2.x_2y_2+r_2:P_3[_P_4]$$

### 5.1.5.3 Implementation and labeling

Cable labeling shall be accomplished via machine printed labels. Text on labels should be a font without serifs, upper case and large enough to be easily read. Labels shall be durably affixed to both ends of each cable conspicuously displayed just prior to each cable being routed into the termination device.

Where cables are diversely routed label colors or other form of identification shall be used to reflect cable route diversity.

The space identifiers ' $f_1s_1$ ' and ' $f_2s_2$ ' may be excluded in an administration system where the telecommunications cabling system only includes a single telecommunications space.

The second space identifier ' $f_2s_2$ ' may be excluded from the identifier if the cable does not extend beyond the telecommunications space (i.e.,  $f_2s_2$  is the same as  $f_1s_1$ ). Additionally, in this circumstance, the ' $f_1s_1$ ' is not required on the cable labels as the space identifier should be obvious to someone working in the room.

#### EXAMPLE 1 – SINGLE 4-PAIR CABLE

For example, the cable connected to first position of the patch panel shown in figure 10 would contain the following label for the cable from patch panel AD02-35 port 01 to patch panel AG03-35 port 01:

+AD02+35:01 / +AG03+35:01

The same cable in cabinet AGO3 would have the following label, which contains the same information, but with the sequence reversed:

+AG03+35:01 / +AD02+35:01

Alternatively, the two halves of the identifier may appear on two lines of text. For example, the label

+AD02+35:01 / +AG03+35:01

may appear instead as:

+AD02+35:01
+AG03+35:01

**EXAMPLE 2 – MULTIFIBER TRUNK WITH MPO & LC CONNECTORS**

A 12-strand multifiber trunk cable equipped with MPO connectors on one end, and LC connectors on the other end as shown in figure 17, resulting in a labeling scheme described in figure 18, and labeling application at the LC end per figure 19.

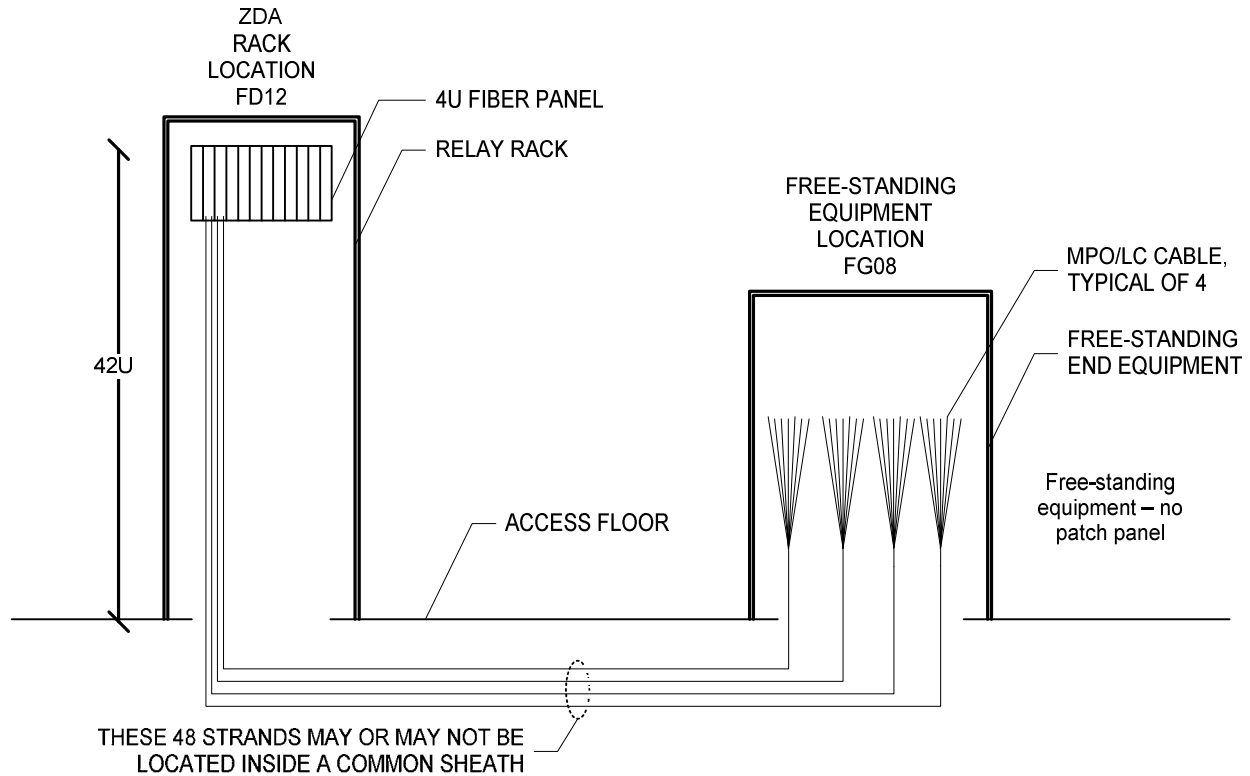

**Figure 17 – Sample MPO/LC layout**

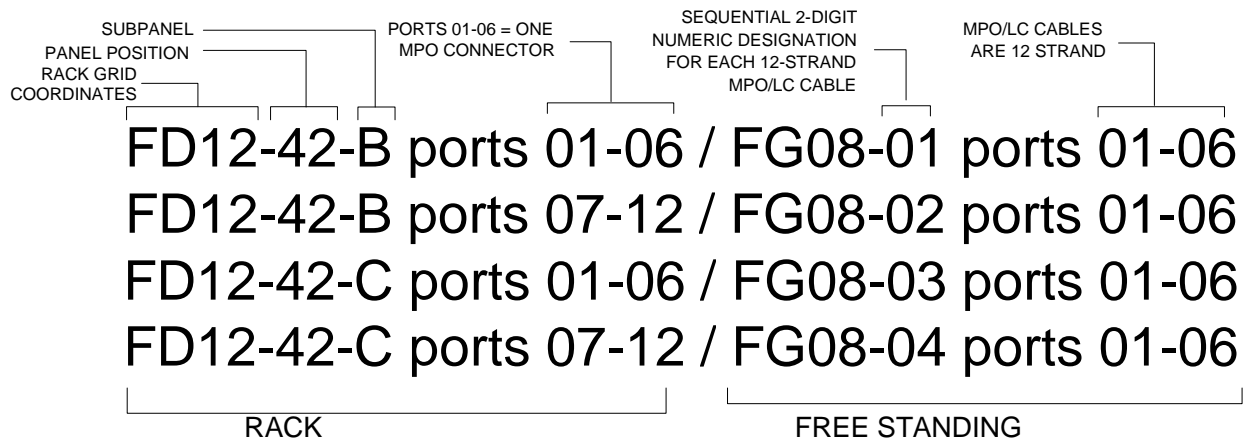

**Figure 18 – Sample MPO/LC labeling scheme**

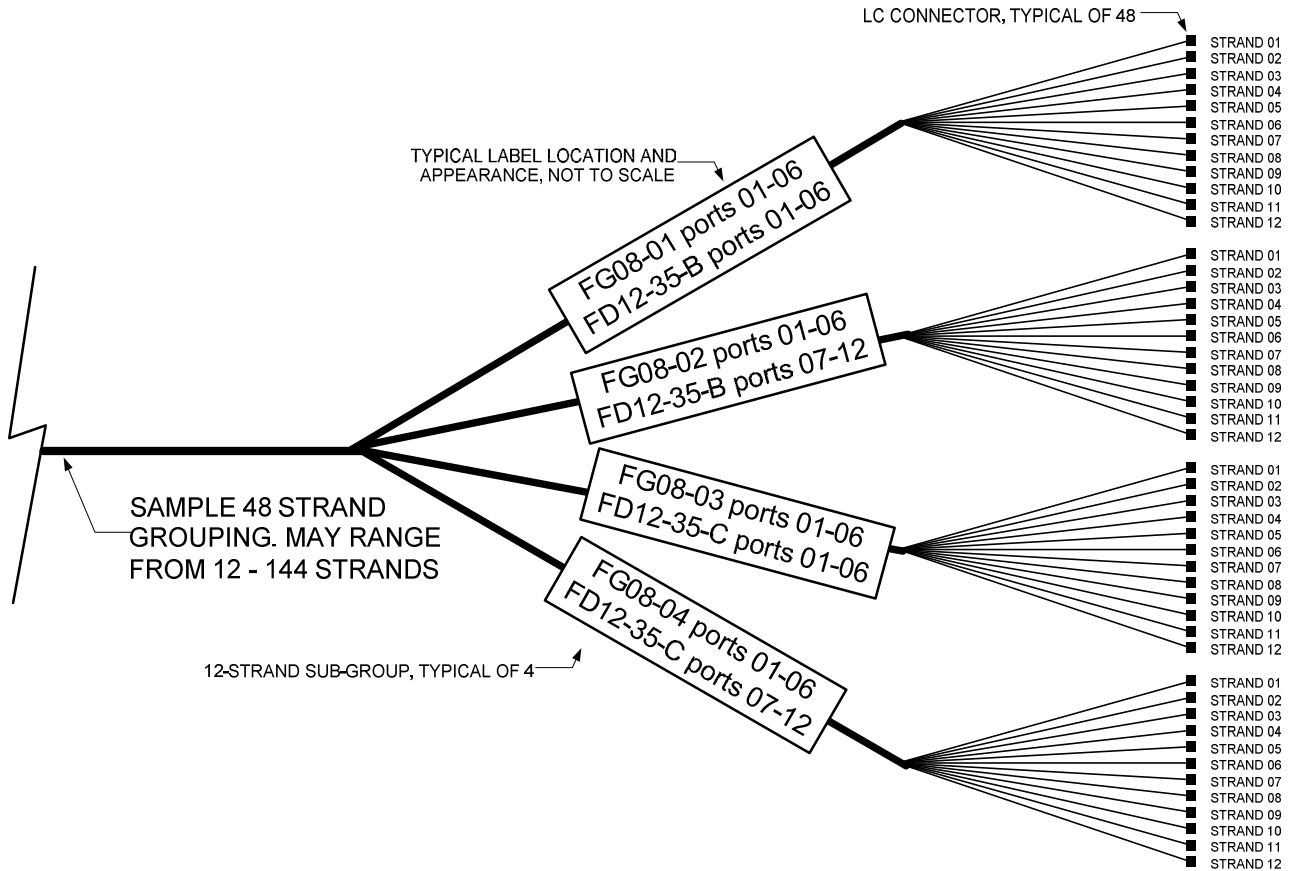

Figure 19 – Sample MPO/LC labeling at LC end

### 5.1.6 Administration of pairs, strands, and groupings within a cable

The administration system can administer individual balanced twisted-pairs and one or more fiber strands. Alternatively, the administration system can administer groupings of pairs or fibers that correspond to a port (for example, a pair of fibers for cables terminating on duplex-LC connectors, 12 fibers for cables terminating on MPO connectors, and 4-pairs for balanced twisted-pair cables terminating on modular jacks).

#### 5.1.6.1 TIA-606-A compatible format

The TIA-606-A compatible format for pair/ports on cables is:

$$f_1s_1.x_1y_1-r_1:P_1 / f_2s_2.x_2y_2-r_2:P_2$$

where:

$f_s.x_1y_1-r_1:p_1$  and  $f_2s_2.x_2y_2-r_2:p_2$  are the port identifiers for the ports/termination points on patch panels or termination blocks on the two ends of the cable as defined in 5.1.4.

The termination closest to the main cross-connect in the telecommunications cabling system hierarchy shall be listed first (before the forward slash). If the terminations are equal within the cabling system hierarchy, then the termination with the lesser alphanumeric identifier shall be listed first.

#### 5.1.6.2 ISO/IEC compatible format

The ISO/IEC TR 14763-2-1 compatible identifier format for pair/ports on cables is:

$$+f_1s_1.x_1y_1+r_1:P_1 / +f_2s_2.x_2y_2+r_2:P_2$$

### 5.1.6.3 Implementation and labeling

Individual optical fibers and balanced pairs are typically color-coded rather than individually labeled except in the case of break-out cables with one connector on one end and multiple connectors on the other (for example, MPO to LC). In this case, every end of the cable shall be labeled as specified in 5.1.5.3.

### 5.1.7 Cabling Subsystem 1 link identifier

A Cabling Subsystem 1 link identifier, unique within the administration system, shall be assigned to each Cabling Subsystem 1 link and to its elements.

#### 5.1.7.1 TIA-606-A compatible format

For TIA-606-A compatible administration systems, the Cabling Subsystem 1 link identifier shall have a format of either:

$$f_1s_1.x_1y_1-r_1:P_1 / f_2s_2.x_2y_2-r_2:P_2 \quad (\text{Cabling Subsystem 1 link terminated on patch panels on both ends})$$

or

$$fs-an \quad (\text{Cabling Subsystem 1 terminated on a work area outlet})$$

The  $f_1s_1.x_1y_1-r_1:P_1 / f_2s_2.x_2y_2-r_2:P_2$  format shall be used for Cabling Subsystem 1 links that are terminated on both ends on patch panels or termination blocks, for example Cabling Subsystem 1 links in computer rooms and equipment rooms. The format is specified in 5.1.6. where  $f_2s_2.x_2y_2-r_2:P_2$  is the port ID of the EO or TO.

The  $fs-an$  format for Cabling Subsystem 1 links shall be used for Cabling Subsystem 1 links terminated on a work area outlet.

$fs-an$  is defined as follows:

- $fs$  = the TS identifier for the location of the patch panel or termination block on which the cable terminates. This portion of the identifier is optional for a class 1 administration system limited to a single equipment room or an administration system limited to a single computer room.
- $a$  = one or two alpha characters uniquely identifying a single patch panel, a group of patch panels with sequentially numbered ports, a termination block, or a group of termination blocks, serving as part of the horizontal cross-connect.
- $n$  = two to four numeric characters designating the port on a patch panel, or the section of a termination block on which a Cabling Subsystem 1 link is terminated in the TS. Enough numeric characters must be used for this portion of the identifier to accommodate all Cabling Subsystem 1 links in a distributor.

#### 5.1.7.2 ISO/IEC compatible format

The ISO/IEC TR 14763-2-1 compatible identifier format for Cabling Subsystem 1 links on cables is either:

$$+f_1s_1.x_1y_1+r_1:P_1=W \quad (\text{Cabling Subsystem 1 link terminated on a work area outlet})$$

or

$$+f_1s_1.x_1y_1+r_1:P_1 / +f_2s_2.x_2y_2+r_2:P_2 \quad (\text{Cabling Subsystem 1 link terminated on patch panels on both ends})$$

The  $+f_1s_1.x_1y_1+r_1:P_1=W$  format is for Cabling Subsystem 1 links that are not terminated on patch panels or termination blocks in the same space. With this format, a Cabling Subsystem 1 link is identified by the port on which the link terminates followed by an equal sign "=" and capital letter "W" ("W" is the letter code specified in IEC 81346-2 for cables).

### 5.1.7.3 Implementation and labeling

For a balanced twisted-pair Cabling Subsystem 1 link, the elements include:

- a) the connecting hardware, e.g., patch panel port or the position of a termination block terminating a four-pair Cabling Subsystem 1 cable
- b) a four-pair Cabling Subsystem 1 cable
- c) an equipment outlet terminating a four-pair Cabling Subsystem 1 cable in the work area
- d) if a consolidation point (CP) is present:
  - i. the segment of four-pair Cabling Subsystem 1 cable extending from the TS to the CP connecting hardware
  - ii. the CP connecting hardware or section of an IDC connector terminating a four-pair Cabling Subsystem 1 cable
  - iii. the segment of four-pair Cabling Subsystem 1 cable extending from the CP connecting hardware to the outlet/connector, if present
- e) if a MUTOA is present, a telecommunications outlet/connector in the MUTOA

For a fiber Cabling Subsystem 1 link, the elements include:

- a) a pair of fiber terminations on a patch panel in the TS
- b) a pair of fibers in a cable
- c) a pair of fiber terminations in the work area
- d) a telecommunications outlet/connector terminating a pair of fibers in the work area
- e) splices
- f) if a consolidation point (CP) is present:
  - i. the segment of fiber cable extending from the TS to the CP connecting hardware
  - ii. the CP connecting hardware or section terminating a pair of fibers
  - iii. the segment of fiber cable extending from the CP connecting hardware to the outlet/connector, if present
- g) if a MUTOA is present, a telecommunications outlet/connector in the MUTOA

The pair of fiber terminations may be two simplex connectors or one duplex connector, and includes adapters, if present.

When consolidation points are used, some elements of the Cabling Subsystem 1 link may not be installed initially.

All elements of a Cabling Subsystem 1 link shall be labeled at the time they are installed with the Cabling Subsystem 1 link identifier.



- The consolidation point identifier should be used on consolidation point labels if optional consolidation point identifiers are used.
- The splice identifier should be used on splice labels if optional splice identifiers are used.
- Patch panels and termination blocks shall be labeled as specified in 5.1.3.1.3. Additionally, if the *fs-an* format is used for Cabling Subsystem 1 link identifiers, in the TS, each patch panel port or position of a termination block shall be labeled with the *an* portion of the identifier. This requirement may be met by labeling a patch panel with the *a* portion of the identifier, and each port with the *n* portion. The port numbers marked on a patch panel by its manufacturer may be used as the *n* portion. Similarly, an IDC connector or group of termination blocks may be labeled with the *a* portion of the identifier, and the section of an IDC connector terminating a four-pair Cabling Subsystem 1 cable labeled with the *n* portion.
- Each end of a Cabling Subsystem 1 cable shall be labeled within 300 mm (12 in) of the end of the cable jacket with the Cabling Subsystem 1 link identifier, which shall be visible on the exposed part of the cable jacket. This shall include each cable end in the TS, at the work area, and at a CP, if present.
- In commercial buildings, industrial premises, data centers, and multi-tenant buildings each individual telecommunications outlet or equipment outlet shall be labeled with the Cabling Subsystem 1 link identifier. The labeling shall appear on the connector, faceplate, or MUTOA, in a way that clearly identifies the individual connector associated with the particular identifier. In single-dwelling residences, labeling of telecommunications outlets is recommended, but not required.
- Certain applications may provide electrical power in addition to data transmission over balanced twisted-pair cables. Visual segregation and identification of ports and outlets with power may be accomplished through the use of the symbol in figure 16.

### 5.1.8 Equipment outlet and telecommunications outlet identifiers

Identifiers for equipment outlets (EOs) or telecommunications outlets (TOs) are optional, however labels may be required for EOs and TOs as specified in 5.1.7.3. Typically these labels only have the Cabling Subsystem 1 link identifier rather than the EO or TO identifier.

If identifiers are assigned to EOs and TOs, they shall be unique within the telecommunications administration system.

#### 5.1.8.1 TIA-606-A compatible format

The TIA-606-A compatible format for EOs and TOs is:

$fs-an=XO$  (Cabling Subsystem 1 link terminated in work area outlet)

or

$fs.x_2y_2-r_2:P_2$  (Cabling Subsystem 1 link terminated on patch panels on both ends)

The *fs-an=XO* format for Cabling Subsystem 1 links has been retained for compatibility with administration systems that use previous revisions of this Standard. The *fs-an* format is defined in 5.1.7. (“X” is the letter code specified in IEC 81346-2 for connections, “O” specifies that the connection is an outlet).

The  $fs.x_2y_2-r_2:P_2$  format shall be used for Cabling Subsystem 1 links that are terminated on both ends on patch panels or termination blocks, for example Cabling Subsystem 1 links in computer rooms and equipment rooms. The format is specified in 5.1.6 where  $fs.x_2y_2-r_2:P_2$  is the port ID of the EO or TO.

### 5.1.8.2 ISO/IEC compatible format

The ISO/IEC 14763-2-1 compatible format for EOs and TOs is:

$+f_1s_1.x_1y_1+r_1:P_1=XO$  (Cabling Subsystem 1 link terminated in work area outlet)

or

$+fs.x_2y_2+r_2:P_2$  (Cabling Subsystem 1 link terminated on patch panels on both ends)

### 5.1.8.3 Implementation and labeling

See 5.1.7.3 regarding labeling of EOs and TOs.

### 5.1.9 Identifiers for consolidation points on Cabling Subsystem 1 links

Identifiers for consolidation points on Cabling Subsystem 1 links are optional; however labels are required for CPs as specified in 5.1.7.3. The labels may consist of the Cabling Subsystem 1 link identifier or the consolidation point identifier.

If identifiers are assigned to consolidation points on Cabling Subsystem 1 links, they shall be unique within the telecommunications administration system.

#### 5.1.9.1 TIA-606-A compatible format

The TIA-606-A compatible format for CPs on Cabling Subsystem 1 links is:

$fs-an=XC[:P_5]$

$fs-an$  is the port identifier or the termination position identifier in the telecommunications room for the Cabling Subsystem 1 link and is defined in 5.1.7.

"=XC" specifies that the component is a consolidation point.

The port on the consolidation point may optionally be identified by a colon ':' and the port number (field  $P_5$  above) after "=XC".

#### 5.1.9.2 ISO/IEC compatible format

The ISO/IEC 14763-2-1 compatible format for CPs on Cabling Subsystem 1 links is:

$+f_1s_1.x_1y_1+r_1:P_1=XC[:P_5]$

#### 5.1.9.3 Implementation and labeling

See 5.1.7.3 regarding labeling of CPs on Cabling Subsystem 1 links.

### 5.1.10 Identifiers for zone distribution area ports

Identifiers for zone distribution area (ZDA) ports on Cabling Subsystem 1 links are optional; however labels are required for ports in ZDAs. The labels may consist of the Cabling Subsystem 1 link identifier or the ZDA port identifier.

If identifiers are assigned to ZDA ports, they shall be unique within the telecommunications administration system.

#### 5.1.10.1 TIA-606-A compatible format

The TIA-606-A compatible format for ZDA ports is:

$$f_1s_1.x_1y_1-r_1:P_1 / f_2s_2.x_2y_2-r_2:P_2=XL[:P_5]$$

The format consists of the Cabling Subsystem 1 link identifier as defined in 5.1.7 followed by “=XL[:P<sub>5</sub>]”,

where:

=XL designates the object as being a ZDA port (“X” is the letter code specified in IEC 81346-2 for connections. “L” specifies that the connection is a ZDA port, L comes from LDP, the ISO/IEC equivalent of the ZDA).

The port on the consolidation point may optionally be identified by a colon ‘:’ and the port number (field P<sub>5</sub> above) after “=XL”.

#### 5.1.10.2 ISO/IEC compatible format

The ISO/IEC 14763-2-1 compatible format for ZDA ports is:

$$+f_1s_1.x_1y_1+r_1:P_1 / +f_2s_2.x_2y_2+r_2:P_2=XL[:P_5]$$

#### 5.1.10.3 Implementation and labeling

See 5.1.7.3 regarding labeling of ZDA ports on Cabling Subsystem 1 links.

#### 5.1.11 Identifiers for splices on Cabling Subsystem 1 links

Identifiers for splices on Cabling Subsystem 1 links are optional. If identifiers are assigned to splices on Cabling Subsystem 1 links, they shall be unique within the telecommunications administration system.

##### 5.1.11.1 TIA-606-A compatible format

The TIA-606-A compatible format for splices on Cabling Subsystem 1 links is:

$$f_1s_1.x_1y_1-r_1:P_1 / f_2s_2.x_2y_2-r_2:P_2=XSz \quad \text{(Cabling Subsystem 1 link terminated on patch panels on both ends)}$$

or

$$fs-an=XSz \quad \text{(Cabling Subsystem 1 link terminated in work area outlet).}$$

The format consists of the Cabling Subsystem 1 link identifier as defined in 5.1.7 followed by “=XSz”,

where:

=XS designates the object as being a splice

z is the approximate distance in meters from the termination point in the telecommunications room or HDA. No two splices on the same cable shall use the same value z.

**5.1.11.2 ISO/IEC compatible format**

The ISO/IEC 14763-2-1 compatible format for splices on Cabling Subsystem 1 links is:

$+f_1s_1.x_1y_1+r_1:P_1=XSz$  (Cabling Subsystem 1 link terminated in work area outlet)

or

$+f_1s_1.x_1y_1+r_1:P_1 / +f_2s_2.x_2y_2+r_2:P_2=XSz$  (Cabling Subsystem 1 link terminated on patch panels on both ends).

**5.1.11.3 Implementation and labeling**

Splices on Cabling Subsystem 1 links shall be labeled. The label shall be either the identifier of the splice or the (if the splice has an identifier), or of the Cabling Subsystem 1 pairs/ports contained within the splice.

**5.1.12 TMGB identifier**

The telecommunications main grounding busbar (TMGB) identifier is used to identify the single TMGB present in a building.

**5.1.12.1 TIA-606-A compatible format**

The TIA-606-A compatible format for the TMGB identifier is:

$fs$ -TMGB

where  $fs$  is the identifier for the space containing the TMGB, see 5.1.1.

-TMGB designates the element as being a telecommunications main grounding busbar.

**5.1.12.2 ISO/IEC compatible format**

The ISO/IEC 14763-2-1 compatible format for the TMGB identifier is:

$+fs=TMGB$

**5.1.12.3 Implementation and labeling**

The TMGB shall be labeled on the front with the TMGB identifier. If it is not practical to label the surface of the TMGB then apply the label on wall near the TMGB. Care should be exercised when applying labels to the surface of the TMGB to ensure that hazardous current is not present in the device.

See Annex B for an overview and examples of telecommunications grounding system identifiers.

**5.1.13 TGB identifier**

The telecommunications grounding busbar (TGB) identifier is used to identify TGBs in the bonding and grounding system. A unique TGB identifier shall be assigned to each TGB.

**5.1.13.1 TIA-606-A compatible format**

The TIA-606-A compatible format for TGB identifiers is:

$fs$ -TGB[ $i$ ]

where *fs* is the identifier for the space containing the TGB, see 5.1.1.

- TGB designates the element as being a telecommunications grounding busbar.
- i* optional sequence number starting at 1 to be used if there is more than one TGB in the space.

#### 5.1.13.2 ISO/IEC compatible format

The ISO/IEC 14763-2-1 compatible format for TGB identifiers is:

+*fs*=TGB[*i*]

#### 5.1.13.3 Implementation and labeling

Each TGB shall be labeled on the front with the TGB identifier. If it is not practical to label the surface of the TGB then apply the label on wall near the TGB. Care should be exercised when applying labels to the surface of the TGB to ensure that hazardous current is not present in the device.

See Annex B for an overview and examples of telecommunications grounding system identifiers.

#### 5.1.14 RGB identifier

The rack grounding busbar (RGB) identifier is used to identify RGBs in racks, cabinets, and frames. This identifier is optional and should be unique.

##### 5.1.14.1 TIA-606-A compatible format

The TIA-606-A compatible format for RGB identifiers is:

*fs.xy*=RGB[*j*]

where *fs.xy* is the identifier of the cabinet, rack, frame, or wall segment identifier as defined in 5.1.2.

- =RGB designates the element as being a rack grounding busbar.
- j* optional sequence number starting at 1 to be used if there is more than one RGB in the cabinet, rack, frame, or wall segment.

##### 5.1.14.2 ISO/IEC compatible format

The ISO/IEC 14763-2-1 compatible format for RGB identifiers is:

+*fs.xy*=RGB[*j*]

##### 5.1.14.3 Implementation and labeling

Each RGB should be labeled with its identifier at a location that is in clear view of someone making a termination on the RGB.

#### 5.1.15 Mesh-BN identifier

The mesh bonding network (mesh-BN) identifier is used to identify common bonding networks in a computer room, equipment room, or other space. This identifier is optional and should be unique.

**5.1.15.1 TIA-606-A compatible format**

The TIA-606-A compatible format for mesh-BN identifiers is:

$$f_s=MBN$$

where  $f_s$  or  $f_s$  is the identifier for the space containing the mesh-BN, see 5.1.1.

=MBN designates the element as being a mesh-BN.

**5.1.15.2 ISO/IEC compatible format**

The ISO/IEC 14763-2-1 compatible format for mesh-BN identifiers is:

$$+f_s=MBN$$

**5.1.15.3 Implementation and labeling**

There is no need to label the mesh-BN, but connections made to the mesh-BN should be labeled.

**5.1.16 BCT identifier**

The bonding conductor for telecommunications (BCT) identifier is used to identify the BCT in the telecommunications bonding and grounding system. This identifier shall be unique.

**5.1.16.1 TIA-606-A compatible format**

The TIA-606-A compatible format for BCT identifiers is:

$$f_{MSM}/f_{ESE}=BCT$$

where

$f_{MSM}$  TS identifier for the space containing the TMGB, see 5.1.1.

$f_{ESE}$  TS identifier for the space, typically the electrical entrance facility, that contains the service equipment (power) ground to which the bonding conductor for telecommunications is attached, see 5.1.1.

=BCT designates the element as being the bonding conductor for telecommunications.

**5.1.16.2 ISO/IEC compatible format**

The ISO/IEC 14763-2-1 compatible format for BCT identifiers is:

$$+f_{MSM}/+f_{ESE}=BCT$$

**5.1.16.3 Implementation and labeling**

Each BCT shall be labeled with its identifier on both ends. The labels shall be durably affixed to both ends conspicuously displayed just prior to the conductor being routed into its termination.

**5.1.17 TBB identifier**

The telecommunications bonding backbone (TBB) identifier is used to identify a TBB in the bonding and grounding system. The TBB is identified by the names of the telecommunications grounding busbars on either end of the TBB. This identifier shall be unique.

**5.1.17.1 TIA-606-A compatible format**

The TIA-606-A compatible format for TBB identifiers is:

$$f_{1S_{1T}}\text{TMGB} / f_{2S_{2T}}\text{-TGB}[i_2]$$

or

$$f_{1S_{1T}}\text{-TGB}[i_1] / f_{2S_{2T}}\text{-TGB}[i_2]$$

where

$f_{1S_{1T}}\text{TMGB}$  is the identifier for TMGB, see 5.1.12.

$f_{1S_{1T}}\text{-TGB}[i_1]$  and  $f_{2S_{2T}}\text{-TGB}[i_2]$  are identifiers for TGBs, see 5.1.13.

**5.1.17.2 ISO/IEC compatible format**

The ISO/IEC 14763-2-1 compatible format for TBB identifiers is:

$$f_{1S_{1T}}\text{=TMGB} / f_{2S_{2T}}\text{=TGB}[i_2]$$

or

$$f_{1S_{1T}}\text{=TGB}[i_1] / f_{2S_{2T}}\text{=TGB}[i_2]$$

**5.1.17.3 Implementation and labeling**

Each TBB shall be labeled with its identifier on both ends. The labels shall be durably affixed to both ends conspicuously displayed just prior to the conductor being routed into its termination.

**5.1.18 GE identifier**

The grounding equalizer (GE) identifier is used to identify a GE in the bonding and grounding system. This identifier should be unique and have the format based on the identifiers of the TGBs on either end of the GE (see 5.1.13) separated by a forward slash '/'.

**5.1.18.1 TIA-606-A compatible format**

The TIA-606-A compatible format for GE identifiers is:

$$f_{1S_{1T}}\text{-TGB}[i_1] / f_{2S_{2T}}\text{-TGB}[i_2]$$

**5.1.18.2 ISO/IEC compatible format**

The ISO/IEC 14763-2-1 compatible format for GE identifiers is:

$$+f_{1S_{1T}}\text{=TGB}[i_1] / +f_{2S_{2T}}\text{=TGB}[i_2]$$

**5.1.18.3 Implementation and labeling**

Each GE shall be labeled with its identifier on both ends. The labels shall be durably affixed to both ends conspicuously displayed just prior to the conductor being routed into its termination.

**5.1.19 Identifier for bonding conductor attached to TMGB**

All bonding conductors attached to a TMGB shall have a unique identifier.

**5.1.19.1 TIA-606-A compatible format**

The TIA-606-A compatible format is:

*fs-TMGB / object*

where:

*fs-TMGB* is the identifier of the TMGB, see 5.1.12.

*object* is the identifier of an object to which the bonding conductor is attached. It can be the identifier of a cabinet/rack (see 5.1.2), a mesh-BN (see 5.1.15), an RGB (see 5.1.14), an electrical panel, a pathway (see 9.4), building steel (e.g., 'bldgsteel'), a cable tray system (e.g., 'cabletrays'), or the identifier of equipment such as a LAN switch.

#### **5.1.19.2 ISO/IEC compatible format**

The ISO/IEC 14763-2-1 compatible format is:

*+fs=TMGB / object*

#### **5.1.19.3 Implementation and labeling**

All bonding conductors attached to a TMGB shall be labeled with their identifiers on both ends. The labels shall be durably affixed to both ends conspicuously displayed just prior to the conductor being routed into its termination.

Note that BCTs, TBBs, and GEs attached to TMGBs are special bonding conductors that have their own format – see 5.1.16, 5.1.17, and 5.1.18 respectively.

#### **5.1.20 Identifier for bonding conductor attached to TGB**

All bonding conductors attached to a TGB shall have a unique identifier.

##### **5.1.20.1 TIA-606-A compatible format**

The TIA-606-A compatible format is:

*fs-TGB / object*

where:

*fs-TGB* is the identifier of the TGB, see 5.1.13.

*object* is the identifier of an object to which the bonding conductor is attached. It can be the identifier of a cabinet/rack (see 5.1.2), a TBB (see 5.1.17), a mesh-BN (see 5.1.15), an RGB (see 5.1.14), an electrical panel, a pathway (see 9.4), building steel (e.g., 'bldgsteel'), a cable tray system (e.g., 'cabletrays'), or the identifier of equipment such as a LAN switch.

##### **5.1.20.2 ISO/IEC compatible format**

The ISO/IEC 14763-2-1 compatible format is:

*+fs=TGB / object*

##### **5.1.20.3 Implementation and labeling**

All bonding conductors attached to a TGB shall be labeled with their identifiers on both ends. The labels shall be durably affixed to both ends conspicuously displayed just prior to the conductor being routed into its termination.



TBBs, and GEs attached to TGBs are bonding conductors that have their own format – see 5.1.17 and 5.1.18 respectively. Note, however, that taps off a TBB are separate conductors and should have their own identifiers – see Annex B for examples.

### 5.1.21 Identifier for bonding conductor attached to mesh-BN

All bonding conductors attached to a mesh-BN should have a unique identifier.

#### 5.1.21.1 TIA-606-A compatible format

The TIA-606-A compatible format is:

$fs=MBN / object$

where:

$fs=MBN$  is the identifier of the mesh-BN, see 5.1.15.

$object$  is the identifier of a object to which the bonding conductor is attached. It can be the identifier of a cabinet/rack (see 5.1.2), an RGB (see 5.1.14), an electrical panel, a pathway (see 9.4), building steel (e.g., 'bldgsteel'), a cable tray system (e.g., 'cabletrays'), or the identifier of equipment such as a LAN switch or PDU.

#### 5.1.21.2 ISO/IEC compatible format

The ISO/IEC 14763-2-1 compatible format is:

$+fs=MBN / object$

#### 5.1.21.3 Implementation and labeling

Bonding conductors attached to a mesh-BN should be labeled on both ends with their identifiers. The labels shall be durably affixed to both ends conspicuously displayed just prior to the conductor being routed into its termination.

### 5.1.22 Identifier for bonding conductor attached to RGB

Bonding conductors attached to a rack grounding bar (RGB) may have identifiers. The identifier should be unique.

#### 5.1.22.1 TIA-606-A compatible format

The TIA-606-A compatible format is:

$fs.xy=RGB[j] / object$

where:

$fs.xy=RGB[j]$  is the identifier of the RGB, see 5.1.14.

$object$  is the identifier of a object to which the bonding conductor is attached. It is typically the identifier of the equipment or patch panel in the rack, frame, or cabinet bonded to the RGB.

#### 5.1.22.2 ISO/IEC compatible format

The ISO/IEC 14763-2-1 compatible format is:

$+fs.xy=RGB[j] / object$

### **5.1.22.3 Implementation and labeling**

Bonding conductors attached to a RGB should be labeled on both ends with their identifiers. The labels shall be durably affixed to both ends conspicuously displayed just prior to the conductor being routed into its termination.

## **5.2 Required records**

In class 1 administration, one Cabling Subsystem 1 link record is required for each Cabling Subsystem 1 link.

Cabling Subsystem 1 link records shall contain the following information:

- a) Cabling Subsystem 1 link identifier (primary indexing identifier, e.g., 1NC2B4-3TRA.1-35:1=W)
- b) cable type (e.g., 4-pair, UTP, category 6, plenum)
- c) location of telecommunications outlet/connector (room, office, or grid location)
- d) outlet connector type (e.g., 8-position modular, T568A, category 6)
- e) cable length (e.g., 51m/166ft)
- f) cross-connect hardware type (e.g., 48-port modular patch panel, T568A, category 6)
- g) service record of link (e.g., passed category 6 at installation 1/12/11, re-terminated and re-tested at cross-connect 4/22/11 due to broken wire).

Additional items of information desired by the system owner or operator may be added at the end of the record, such as, the location of test results, the location of the outlet within the room or office, or other telecommunications outlet/connectors at same location (generally, the other outlet connectors in the same faceplate).

## **6 CLASS 2 ADMINISTRATION**

Class 2 administration addresses infrastructure with one or more telecommunications spaces (TSs) in a single building.

### **6.1 Infrastructure identifiers**

The following infrastructure identifiers shall be required in class 2 administration, when the corresponding elements are present:

- a) identifiers required in class 1 administration (see 5.1 for requirements for TS, Cabling Subsystem 1 link, TMGB, and TGB identifiers)
- b) building Cabling Subsystem 2 and 3 (backbone) cable identifiers
- c) building Cabling Subsystem 2 and 3 port identifiers
- d) firestopping location identifiers.

Class 2 administration may additionally include pathway identifiers. See clause 9 for examples of additional optional identifiers.

Additional information may be enclosed by parentheses after the end of the required format of an identifier.

### 6.1.1 Building Cabling Subsystem 2 and 3 cable identifiers

A unique building Cabling Subsystem 2 or 3 cable identifier shall be assigned to each Cabling Subsystem 2 and 3 cable.

#### 6.1.1.1 TIA-606-A compatible format

The TIA-606-A compatible format for building Cabling Subsystem 2 and 3 cable identifiers is:

$$f_1s_1.x_1y_1-r_1:P_1[-P_2] / f_2s_2.x_2y_2-r_2:P_3[-P_4]$$

or

$$f_1s_1/f_2s_2-n$$

The format ' $f_1s_1.x_1y_1-r_1:P_1[-P_2]/f_2s_2.x_2y_2-r_2:P_3[-P_4]$ ' is defined in 5.1.5.

The  $f_1s_1/f_2s_2-n$  format has been retained for compatibility with administration systems that use previous revisions of this Standard. This format should only be used in buildings with existing Cabling Subsystem 2 or 3 cables that use the  $f_1s_1/f_2s_2-n$  identifier format.

$f_1s_1/f_2s_2-n$  is defined as follows:

$f_1s_1$	TS identifier for the space containing the termination of one end of the Cabling Subsystem 2 or 3 cable.
$f_2s_2$	TS identifier for the space containing the termination of the other end of the Cabling Subsystem 2 or 3 cable.
$n$	one or two alphanumeric characters identifying a single cable with one end terminated in the TS designated $f_1s_1$ and the other end terminated in the TS designated $f_2s_2$ .

The termination closest to the main cross-connect in the telecommunications cabling system hierarchy shall be listed first. If the terminations are equal within the cabling system hierarchy, the TS with the lesser alphanumeric identifier shall be listed first.

#### 6.1.1.2 ISO/IEC compatible format

The ISO/IEC 14763-2-1 compatible format for building Cabling Subsystem 2 and 3 cable identifiers is:

$$+f_1s_1.x_1y_1+r_1:P_1[_P_2] /+f_2s_2.x_2y_2+r_2:P_3[_P_4]$$

#### 6.1.1.3 Implementation and labeling

Cables shall be labeled on both ends.

Cable labeling shall be accomplished via machine printed labels. Text on labels should be a font without serifs, upper case and large enough to be easily read. Labels shall be durably affixed to both ends of each cable conspicuously displayed prior to each cable being routed into the termination device and within 300 mm (12 in) of the end of the cable jacket. Where cables are diversely routed between patch panels, label colors or other form of identification shall be used to reflect cable route diversity.

For example, the building Cabling Subsystem 2 cable identifier between the following two locations:

1TER	(1 <sup>st</sup> floor Telecom Entrance Room – which corresponds to the $f_1s_1$ field)
AD04	(cabinet at grid coordinates AD04 – which corresponds to the $x_1y_1$ field)

RU 40	(patch panel at rack unit 40 – which corresponds to the $r_1$ field)
Ports 1-24	(corresponds to $P_1$ - $P_2$ field)
3TRC	(3 <sup>rd</sup> floor Telecom Room C – which corresponds to the $f_2S_2$ field)
Rack 2	(which corresponds to the $x_2y_2$ field)
RU 45	(patch panel at rack unit 45 – which corresponds to the $r_2$ field)
Ports 1-24	(corresponds to $P_3$ - $P_4$ field).

Would have the identifier in the  $f_1S_1.X_1Y_1-r_1:P_1[-P_2] / f_2S_2.X_2Y_2-r_2:P_3[-P_4]$  format:

1TER.AD04:1-24/3TRC.2-45:1-24

### 6.1.2 Pairs, strands, and grouping identifiers for Building Cabling Subsystem 2 and 3

Each pair or fiber strand grouping corresponding to a port on a building Cabling Subsystem 2 or 3 cable shall have a unique identifier.

#### 6.1.2.1 TIA-606-A compatible format

The TIA-606-A compatible format for pairs or ports on building Cabling Subsystem 2 and 3 cables identifiers is:

$f_1S_1.X_1Y_1-r_1:P_1 / f_2S_2.X_2Y_2-r_2:P_2$

or

$f_1S_1/f_2S_2-n.d$

The format ' $f_1S_1.X_1Y_1-r_1:P_1/f_2S_2.X_2Y_2-r_2:P_2$ ' is defined in 5.1.6.

The  $f_1S_1/f_2S_2-n.d$  format shall be used for Cabling Subsystem 2 and 3 cables that use the  $f_1S_1/f_2S_2-n$  format.  $f_1S_1/f_2S_2-n.d$  is defined as follows:

$f_1S_1/f_2S_2-n$  the Cabling Subsystem 2 or 3 cable identifier as specified above in 6.1.1.

$d$  two to four numeric characters identifying a balanced twisted-pair group, fiber, or grouping corresponding to a port.

#### 6.1.2.2 ISO/IEC compatible format

The ISO/IEC 14763-2-1 compatible format for pairs or ports on building Cabling Subsystem 2 and 3 cables is:

$+f_1S_1.X_1Y_1+r_1:P_1 / +f_2S_2.X_2Y_2+r_2:P_2$

#### 6.1.2.3 Implementation and labeling

Individual optical fibers and balanced pairs are typically color-coded rather than individually labeled except in the case of break-out cables with one connector on one end and multiple connectors on the other (for example, MPO to LC). In this case, every end of the cable shall be labeled as specified in 5.1.5.3.

### 6.1.3 Building Cabling Subsystem 2 and 3 splice identifier

Identifiers for splices on building Cabling Subsystem 2 and 3 cables are optional. If identifiers are assigned to splices on building Cabling Subsystem 2 and 3 cables, they shall be unique within the telecommunications administration system.

### 6.1.3.1 TIA-606-A compatible format

The TIA-606-A compatible format for building Cabling Subsystem 2 and 3 cable splice identifiers is:

$$f_1s_{1.x_1y_1-r_1}:P_1 / f_2s_{2.x_2y_2-r_2}:P_2=XSz$$

or

$$fs_1/fs_2-n.d=XSz$$

The first format ' $f_1s_{1.x_1y_1-r_1}:P_1/f_2s_{2.x_2y_2-r_2}:P_2=XSz$ ' is defined in 5.1.7.

The  $fs_1/fs_2-n.d=XSz$  format shall only be used for Cabling Subsystem 2 and 3 cables that use the  $fs_1/fs_2-n$  format. This format is defined as follows:

$fs_1/fs_2-n.d$	the building Cabling Subsystem 2 or 3 pair/port identifier as specified in 6.1.2.
=XS	the letters 'XS' designate the element as being a splice.
z	the approximate distance along the cable of the splice from the patch panel in $fs_1$ in meters. Each splice on the same Cabling Subsystem 2 or 3 cable pair/port shall use a different value z.

### 6.1.3.2 ISO/IEC compatible format

The ISO/IEC 14763-2-1 compatible format for building Cabling Subsystem 2 and 3 cable splice identifiers is:

$$+f_1s_{1.x_1y_1+r_1}:P_1 / +f_2s_{2.x_2y_2+r_2}:P_2=XSz$$

### 6.1.3.3 Implementation and labeling

Splices on Cabling Subsystem 2 and 3 cables shall be labeled. The label shall be either the identifier of the splice or the (if the splice has an identifier), or of the Cabling Subsystem 2 or 3 pairs/ports contained within the splice.

### 6.1.4 Firestopping location identifier

A firestopping location identifier shall identify each installation of firestopping material.

All firestopping location identifiers in a single infrastructure should have the same format where possible.

#### 6.1.4.1 TIA-606-A compatible format

The TIA-606-A compatible format for firestopping location identifiers is:

$$[[c_1-]b_1-][f_1]s_1 / [[c_2-]b_2-][f_2]s_2=U(n[(d)])=F[m]$$

or

$$f-FSLn(h)$$

The first format identifies the pathway in which the firestop is located. The pathway identifier ' $[[c_1-]b_1-][f_1]s_1/[[c_2-]b_2-][f_2]s_2=U(n[(d)])$ ' is defined in 9.4.

=F	specifies that the element is a firestopping location.
m	optional approximate distance of the firestopping location in meters along the pathway from the $f_1 s_1$ end of the pathway.

The legacy format for the firestopping location identifier specified in TIA-606-A is  $f\text{-FSL}n(h)$ , where:

- $f$  numeric character(s) identifying the floor of the building occupied by the TS or computer room.
- FSL the letters 'FSL' that designate the element as being a firestopping location.
- $n$  two to four numeric characters identifying one firestopping location.
- $h$  one numeric character specifying the hour rating of the firestopping system.

#### 6.1.4.2 ISO/IEC compatible format

The ISO/IEC 14763-2-1 compatible format for firestopping location identifiers is:

$$[[+c_1]+b_1][+f_1]s_1 / [[+c_2]+b_2][+f_2]s_2 = U(n[(d)]) = F[m]$$

#### 6.1.4.3 Implementation and labeling

Each firestopping location shall be labeled at each location where firestopping is installed, on each side of the penetrated fire barrier, within 300 mm (12 in) of the firestopping material.

### 6.2 Required records

The following records shall be required in class 2 administration:

- a) Cabling Subsystem 1 link records as specified in 5.2.1
- b) one TS record for each TS
- c) one Cabling Subsystem 2 or 3 cable record for each Cabling Subsystem 2 or 3 cable
- d) one TMGB record for each TMGB
- e) one TGB record for each TGB
- f) one firestopping location record for each firestopping location.

#### 6.2.1 TS records

The TS records shall contain the following information:

- a) TS identifier (primary indexing identifier, e.g., SFO2-2A)
- b) type of TS (e.g., TR, CTR, ER, CER, or EF)
- c) building room number
- d) key or access card identification
- e) contact person
- f) hours of access.

Additional items of information desired by the system owner or operator may be added to each record, such as, environmental information (e.g., electrical service, HVAC present) or non-telecommunications systems present. See clause 9 for implementation of additional identifiers.

#### 6.2.2 Building Cabling Subsystem 2 and 3 cable records

The building Cabling Subsystem 2 and 3 cable records shall contain the following information:

- a) building Cabling Subsystem 2 and 3 cable identifier (primary indexing identifier, e.g., SFO2-1CR.D5-42:1-24/SFO2-3TRA.1-42:1-24)

- b) type of cable (e.g., 48 fiber OM3)
- c) type of connecting hardware, first TS (e.g., 72 duplex LC patch panel)
- d) type of connecting hardware, second TS (e.g., 24 duplex LC patch panel)
- e) cross-connect table relating each Cabling Subsystem 2 and 3 cable pair or fiber to other Cabling Subsystem 2 and 3 cable pairs or fibers or to a Cabling Subsystem 1 link.

Additional items of information desired by the system owner or operator may be added to each record.

### 6.2.3 TMGB records

The telecommunications main grounding busbar (TMGB) records shall contain the following information:

- a) TMGB identifier (primary indexing identifier, e.g., 1A=TMGB)
- b) location of the TMGB (building room number)
- c) location of attachment of TMGB to electrical system ground or building structural steel
- d) location of test results for any tests performed on the TMGB, such as resistance to ground.

Additional items of information desired by the system owner or operator, such as the dimensions of the TMGB or the number of grounding positions available, may be added to each record.

### 6.2.4 TGB records

The telecommunications grounding busbar (TGB) records shall contain the following information:

- a) TGB identifier (primary indexing identifier, e.g., 3A=TGB)
- b) location of TGB (building room number)
- c) location of test results for any tests performed on the TGB, such as resistance to ground.

Additional items of information desired by the system owner or operator, such as the dimensions of the TGB or the number of grounding positions available, may be added to each record.

### 6.2.5 Firestopping records

The firestopping records shall contain the following information:

- a) firestopping location identifier (primary indexing identifier, e.g., SFO2-2A/3A=CD1=F)
- b) location of the firestopping installation (e.g., room number and location within room)
- c) type and manufacturer of firestopping installed
- d) date of firestopping installation
- e) name of installer of firestopping material
- f) service record of firestopping location (e.g., 4/22/2011 firestopping removed and replaced with same type by ABC Cabling to add cabling runs).

Additional items of information desired by the system owner or operator may be added to each record.

## **7 CLASS 3 ADMINISTRATION**

Class 3 administration addresses infrastructure with multiple buildings at a single site.

### **7.1 Infrastructure identifiers**

The following infrastructure identifiers shall be required in class 3 administration:

- a) identifiers required in class 2 administration (see 6.1)
- b) building identifier
- c) campus cable identifier
- d) campus cable pair or fiber identifier

The following infrastructure identifiers are optional in class 3 administration:

- a) identifiers optional in class 2 administration (see 6.1)
- b) outside plant pathway element identifier
- c) campus pathway or element identifier

Additional identifiers may be added if desired. See clause 9 for examples of additional optional identifiers.

Additional information may be enclosed in parentheses after the end of the required format of an identifier.

#### **7.1.1 Campus or site identifier**

A unique campus or site identifier shall be assigned to each campus or site.

##### **7.1.1.1 TIA-606-A compatible format**

The TIA-606-A compatible format for building identifiers is:

*c*

where *c* is one or more alphanumeric characters identifying a campus or site.

##### **7.1.1.2 ISO/IEC compatible format**

The ISO/IEC 14763-2-1 compatible format for building identifiers is:

+*c*

##### **7.1.1.3 Implementation**

If a site or campus must be identified, and no other scheme is otherwise employed by the organization, the designation should be based on a recognized code system, for example the IATA airport codes:

SFO2 (for site 2 within the region served by SFO airport)

There are no labeling requirements for the campus or site identifier.



## 7.1.2 Building identifier

A unique building identifier shall be assigned to each building.

### 7.1.2.1 TIA-606-A compatible format

The TIA-606-A compatible format for building identifiers is:

$c-b$  (with campus identifier)

or

$b$  (without campus identifier)

where:

$c$  one or more alphanumeric characters identifying a campus or site (see 7.1.1). This field (and the hyphen that follows it) is not required if the building is not on a campus or site or if the building identifier alone is adequate to uniquely identify the building within the telecommunications administration system.

$b$  one or more alphanumeric characters identifying the building.

### 7.1.2.2 ISO/IEC compatible format

The ISO/IEC 14763-2-1 compatible format for building identifiers is:

$+c+b$  (with campus identifier)

or

$+b$  (without campus identifier).

### 7.1.2.3 Implementation and labeling

Consider using a building identifier system utilizing a code system such as the building codes used by the facilities department or the IATA airport codes.

There are no labeling requirements for the building identifier.

## 7.1.3 Inter-building cable identifier

A unique identifier shall be assigned to each inter-building cable.

### 7.1.3.1 TIA-606-A compatible format

The TIA-606-A compatible format for inter-building cable identifiers is:

$c_1-b_1-f_1S_1.X_1Y_1-r_1:P_1[-P_2] / c_2-b_2-f_2S_2.X_2Y_2-r_2:P_3[-P_4]$

or

$c_1-b_1-f_1S_1/c_2-b_2-f_2S_2-n$

The formats are similar to those used for building Cabling Subsystem 2 and 3 cabling in 6.1.1 with the addition of the campus and building identifiers from 7.1.2.

With the first format, the patch panel closest to the main cross-connect in the campus or inter-building telecommunications cabling system hierarchy shall be listed first (patch panel #1) if such a hierarchy exists. If the patch panels are equal within the cabling system hierarchy, then the patch panel with the lesser alphanumeric identifier shall be listed first.

The  $c_1-b_1-f_1s_1/c_2-b_2-f_2s_2-n$  format has been retained for compatibility with administration systems that use previous revisions of this Standard. With this format, the building with the lesser  $c-b$  alphanumeric identifier shall be listed first.

### 7.1.3.2 ISO/IEC compatible format

The ISO/IEC 14763-2-1 compatible format for inter-building cable identifiers is:

$$+c_1+b_1+f_1s_1.x_1y_1+r_1:P_1[_P_2] / +c_2+b_2+f_2s_2.x_2y_2+r_2:P_3[_P_4]$$

### 7.1.3.3 Implementation and labeling

Cable labeling shall be accomplished via machine printed labels. Text on labels should be a font without serifs, upper case and large enough to be easily read. Labels shall be durably affixed to both ends of each cable conspicuously displayed prior to each cable being routed into the termination device and within 300 mm (12 in) of the end of the cable jacket. Where cables are diversely routed between patch panels, label colors or other form of identification shall be used to reflect cable route diversity.

## 7.1.4 Inter-building cable pair / port identifier

A unique identifier shall be assigned to each port/pair on inter-building cable.

### 7.1.4.1 TIA-606-A compatible format

The TIA-606-A compatible format for inter-building cable pair/port identifiers is:

$$c_1-b_1-f_1s_1.x_1y_1-r_1:P_1 / c_2-b_2-f_2s_2.x_2y_2-r_2:P_3$$

or

$$c_1-b_1-f_1s_1/c_2-b_2-f_2s_2-n.d$$

The formats are similar to those used for building Cabling Subsystem 2 and 3 cable pairs/ports in 6.1.2 with the addition of the campus and building identifiers from 7.1.2.

### 7.1.4.2 Implementation and labeling

Individual optical fibers and balanced pairs are typically color-coded rather than individually labeled except in the case of break-out cables with one connector on one end and multiple connectors on the other (for example, MPO to LC). In this case, every end of the cable shall be labeled as specified in 5.1.5.3.

### 7.1.4.3 ISO/IEC compatible format

The ISO/IEC 14763-2-1 compatible format for inter-building cable pair/port identifiers is:

$$+c_1+b_1+f_1s_1.x_1y_1+r_1:P_1 / +c_2+b_2+f_2s_2.x_2y_2+r_2:P_3$$

## 7.1.5 Inter-building cable splice identifier

Splices on inter-building cables shall be labeled. The label shall be either the identifier of the splice or the (if the splice has an identifier), or of the inter-building pairs/ports contained within the splice.

### 7.1.5.1 TIA-606-A compatible format

The TIA-606-A compatible format for inter-building cable splice identifiers is:

$$c_1-b_1-f_1s_1.x_1y_1-r_1:P_1 / c_2-b_2-f_2s_2.x_2y_2-r_2:P_3=XSz$$

or

$$c_1-b_1-f_1s_1/c_2-b_2-f_2s_2-n.d=XSz$$

The formats are similar to those used for building Cabling Subsystem 2 and 3 cable splices in 6.1.3 with the addition of the campus and building identifiers from 7.1.2.

### 7.1.5.2 ISO/IEC compatible format

The ISO/IEC 14763-2-1 compatible format for inter-building cable splice identifiers is:

$$+c_1+b_1+f_1s_1.x_1y_1+r_1:P_1/+c_2+b_2+f_2s_2.x_2y_2+r_2:P_2=XSz$$

### 7.1.5.3 Implementation and labeling

Identifiers for splices on building Cabling Subsystem 2 and 3 cables are optional. If identifiers are assigned to splices on building Cabling Subsystem 2 and 3 cables, they shall be unique within the telecommunications administration system.

## 7.2 Required records

In class 3 administration the following records shall be required:

- a) records required in class 2 administration (see 6.2)
- b) one building record for each building
- c) one campus (inter-building) cable record for each campus cable.

### 7.2.1 Building records

The building records shall contain the following information:

- a) building name
- b) building location (e.g., street address)
- c) a list of all TSs
- d) contact information for access
- e) access hours.

Additional items of information desired by the system owner or operator may be added to each record.

### 7.2.2 Campus cable records

The campus cable records shall contain the following information:

- a) campus cable identifier (the primary indexing identifier, e.g., DFW1-ADM-1A.B10.42:1-18/DFW1-ENG-1A.E20.42:1-18)
- b) type of cable (e.g., 36 optical fiber, 50/125 $\mu$ m, gel filled, copper armor)
- c) type of connecting hardware, first TS (e.g., 36 LC duplex adapter panel)
- d) type of connecting hardware, second TS (e.g., 36 LC duplex adapter panel)
- e) table relating terminations to other Cabling Subsystem 1, 2, and 3 links, to which they are cross-connected.

Additional items of information desired by the system owner or operator may be added to each record.

## **8 CLASS 4 ADMINISTRATION**

Class 4 administration addresses infrastructure with multiple sites or campuses.

### **8.1 Infrastructure identifiers**

The following infrastructure identifiers shall be required in class 4 administration:

- a) identifiers required in class 3 administration (see 7.1)
- b) campus or site identifier.

The following infrastructure identifiers are optional in class 4 administration:

- a) identifiers optional in class 3 administration (see 7.1)
- b) inter-campus element identifier.

Additional identifiers may be added if desired. See clause 9 for examples of additional optional identifiers.

Additional information may be enclosed in parentheses after the end of the required format of an identifier.

### **8.2 Required records**

The following records shall be required in class 4 administration:

- a) records required in class 3 administration (see 7.2)
- b) one campus or site record for each campus or site.

The campus or site records shall contain the following information:

- a) campus or site name
- b) campus or site location (e.g., street address)
- c) contact information for local administrator of infrastructure
- d) list of all buildings at the site or campus
- e) location of main cross-connect, if applicable
- f) access hours.

Additional items of information desired by the system owner or operator may be added to each record.

## **9 OPTIONAL IDENTIFIERS FOR INFRASTRUCTURE ELEMENTS**

### **9.1 General**

This clause includes formats of optional identifiers for copper, fiber, coax, wireless and device elements as well as for areas, spaces, pathways, and locations. Many of the elements listed in this clause are found in larger installation environments and often require labels and identifiers to allow the elements to be effectively managed. Objects such as cables or conduits, which span multiple telecommunications spaces, should be labeled with the same identifier in each space where they are accessible.

## 9.2 Absolute and partial identifiers

The intent of this clause is to establish guidelines and serve as a foundation for consistent identification of these elements. The identifiers constructed in this clause are “absolute” or complete identifiers. Since much of the information expressed in this absolute format may be inferred from the element itself and its location, a shortened form of the identifier may be used in certain situations. A shortened (“partial” or “local”) identifier will normally be preferred on labels.

## 9.3 Outdoor telecommunications space identifiers

### 9.3.1 TIA-606-A compatible format

The TIA-606-A compatible identifier format for outdoor telecommunications spaces (e.g., maintenance holes, handholes, pedestals, outdoor cabinets) is:

$c-T[(g)]$

or

$c-UUU[(g)]$

where

$c$  optional campus identifier.

$T$  identifier of outside space (e.g., MH101 for maintenance hole #101).

$g$  optional field with the Global Positioning System (GPS), Universal Transverse Mercator (UTM), or map coordinates of the outdoor telecommunications space. The coordinate system used for this field shall be consistently applied throughout the administration system.

$UUU$  element – see 9.5.

TIA-606-A compatible format outdoor space identifiers may be enclosed in square brackets as specified in TIA-606-A.

### 9.3.2 ISO/IEC compatible format

The ISO/IEC 14763-2-1 compatible identifier format for outdoor telecommunications spaces is:

$+c+T[(g)]$

### 9.3.3 Implementation and labeling

For example, Maintenance Hole 12 on campus LAX1 could have the identifier:

LAX1-MH12

The label could simply be MH12, since the site location would be obvious to someone on the site.

The campus identifier does not apply for outdoor telecommunications spaces that are not on a campus. For such locations, the GPS coordinates of the maintenance hole could be used to uniquely identify a maintenance hole. For example, the maintenance hole at GPS coordinates 37.797413,-122.414925 could have the identifier:

MH(37.797413,-122.414925)

## 9.4 Pathway identifiers

### 9.4.1 Intra-space pathway identifiers

#### 9.4.1.1 TIA-606-A compatible format

The TIA-606-A compatible identifier format for pathways within a space is:

$$c-b-fs.x_1y_1/x_2y_2=U(n[(d)])$$

or

$$c-b-fs-UUU.n.d(q)$$

where

<i>c</i>	Optional campus identifier (see 7.1.1)
<i>b</i>	Optional building identifier (see 7.1.2)
<i>fs</i>	The identifier of the space in which the pathway is located (see 5.1.1)
$x_1y_1$	The room grid coordinates for the one end of the pathway (see 5.1.2.1) – grid coordinates with the lowest x coordinate should be $x_1y_1$ . If the x coordinates are the same, the one with the lowest y coordinate should be $x_1y_1$ .
$x_2y_2$	The room grid coordinates for the other end of the pathway (see 5.1.2.1)
=U	'U' following the equal sign specifies that the element is a pathway
<i>n</i>	Numeric characters identifying the pathway system sequence number – for example, conduit number in a multiple conduit duct bank. If there is only one element, <i>n</i> shall be 1.
<i>d</i>	Innerduct, sub-duct, or tray section – this sequence number is the minor element identifier is optional if the pathway system is not subdivided.
<i>UUU</i>	Element – see 9.5
<i>q</i>	Optional user defined additional qualifying information such as pathway type - see table 3 for suggestions.

#### 9.4.1.2 ISO/IEC compatible format

The ISO/IEC 14763-2-1 compatible identifier format for pathways within a space is:

$$+c+b+fs.x_1y_1/x_2y_2=U(n[(d)])$$

#### 9.4.1.3 Implementation and labeling

Intra-space pathways should be permanently labeled on both ends with their pathway identifiers. The labels should be on the exterior of the pathway so as not to be obscured when a cable is placed in the pathway. The label shall be permanent and legible to someone installing a cable in the pathway. The space portion of the field may be omitted for brevity.

## 9.4.2 Building pathway identifiers

### 9.4.2.1 TIA-606-A compatible format

The TIA-606-A compatible identifier format for pathways between spaces within a building is:

$$c-b-f_1s_1.x_1y_1/f_2s_2.x_2y_2=U(n[(d)])$$

or

$$c-b-f_1s_1/f_2s_2-UUU.n.d(q)$$

where the fields are defined in 9.4.1.1. The spaces at the ends of the pathway are  $f_1s_1$  and  $f_2s_2$  where  $f_1s_1$  is the end of the pathway closest in the telecommunications cabling topology hierarchy closest to the main distributor. If the two spaces are equally distant from the main distributor within the cabling topology, then the space with the lowest sort order alphanumeric identifier shall be  $f_1s_1$ .

#### 9.4.2.2 ISO/IEC compatible format

The ISO/IEC 14763-2-1 compatible identifier format for pathways between spaces within a building is:

$$+c+b+f_1s_1.x_1y_1/ +f_2s_2.x_2y_2=U(n[(d)])$$

#### 9.4.2.3 Implementation and labeling

Building pathways should be permanently labeled on both ends with their pathway identifiers. The labels should be on the exterior of the pathway so as not to be obscured when a cable is placed in the pathway. The label shall be permanent and legible to someone installing a cable in the pathway. The campus and building portion of the field may be omitted for brevity.

### 9.4.3 Building entrance pathway identifiers

#### 9.4.3.1 TIA-606-A compatible format

The TIA-606-A compatible identifier format for building entrance pathways is:

$$c-b-f_1s_1.x_1y_1=U(n[(d)])$$

or

$$c-b-f_1s_1-EN.n.d(q)$$

where the fields are defined above in 9.4.1.1. For the last format, the letters 'EN' specify that the pathway is an entrance pathway.

#### 9.4.3.2 ISO/IEC compatible format

The ISO/IEC 14763-2-1 compatible identifier format for building entrance pathways is:

$$+c+b+f_1s_1.x_1y_1=U(n[(d)])$$

#### 9.4.3.3 Implementation and labeling

Building entrance pathways should be permanently labeled on both ends with their pathway identifiers. The labels should be on the exterior of the pathway so as not to be obscured when a cable is placed in the pathway. The label shall be permanent and legible to someone installing a cable in the pathway. The campus and building portion of the field may be omitted for brevity.

### 9.4.4 Outside plant pathway identifiers

#### 9.4.4.1 TIA-606-A compatible format

The TIA-606-A compatible identifier format for outside plant pathways is:

$$c_1-b_1-f_1s_1.x_1y_1/ c_2-b_2-f_2s_2.x_2y_2=U(n[(d)])$$

or

$$c_1-b_1-f_1s_1/ c_2-b_2-f_2s_2-UUU.n.d(q)$$

where the fields are defined above in 9.4.1.1.

Outdoor telecommunications space identifiers (e.g., [+c]+T[(g)] from 9.3.1 may be used in place of the building space identifier (e.g., [+c]+b+[f]s) within the outside plant pathway identifier.

The space closest to the main distributor of the campus or administration system cabling system hierarchy (if one exists) shall be listed first. If no such hierarchy exists or if the spaces are equivalent in the hierarchy, then the lowest sort order alphanumeric identifier shall be listed first.

#### 9.4.4.2 ISO/IEC compatible format

The ISO/IEC 14763-2-1 compatible identifier format for outside plant pathways is:

$$+c_1+b_1+f_1s_1.x_1y_1/ +c_2+b_2+f_2s_2.x_2y_2=U(n[(d)])$$

#### 9.4.4.3 Implementation and labeling

Outside plant pathways should be permanently labeled on both ends with their pathway identifiers. The labels should be on the exterior of the pathway so as not to be obscured when a cable is placed in the pathway. The label shall be permanent and legible to someone installing a cable in the pathway.

### 9.4.5 Campus entrance pathway identifiers

#### 9.4.5.1 TIA-606-A compatible format

The TIA-606-A compatible identifier format for campus entrance pathways that terminate in an outdoor space such as a maintenance hole is:

$$c-T[(g)]=U(n[(d)])$$

or

$$c-EN.n.d(q)$$

where the fields are defined above in 9.3.1 and 9.4.1.1.

#### 9.4.5.2 ISO/IEC compatible format

The ISO/IEC 14763-2-1 compatible identifier format for campus entrance pathways is:

$$+c+T[(g)]=U(n[(d)])$$

#### 9.4.5.3 Implementation and labeling

Campus entrance pathways should be permanently labeled on both ends with their pathway identifiers. The labels should be on the exterior of the pathway so as not to be obscured when a cable is placed in the pathway. The label shall be permanent and legible to someone installing a cable in the pathway.

### 9.5 Examples of elements and identifiers

The following is a list of elements and associated identifiers that can be used in the UUU position of the above identifier: Combine the type letter (i.e., C - for Copper and F -for Fiber) with the 2 or 3 character element identifier (PL - Panel) to derive the UUU code. A copper patch panel would be CPL, a fiber panel would be FPL and a conduit would be PCN.



The examples provided in table 3 are not intended to be an exhaustive list of identifiers. When additional identifiers are used, they should be carefully chosen so as not to conflict with standard industry usage.

Following are three examples of identifying elements of telecommunications infrastructure using the formats described in clauses 9.3 and 9.4.

Example 1:

A sub-duct within a maintenance hole that is in a pathway between the Entrance Facilities of two buildings on the same campus would be identified using this format:

[b<sub>1</sub>-fs<sub>1</sub>]/[b<sub>2</sub>-fs<sub>2</sub>]-UUU.n.d(q)

If the first building is the Steele Building, identified as STE, and the pathway ends in the Entrance Facility on the first floor, identified as 1A, the first segment of the identifier would be [STE-1A].

If the second building is the Teach Building, identified as TEA, and the pathway ends in the Entrance Facility, identified as 2B, the second segment of the identifier is [TEA-2B].

The maintenance hole descriptor from table 3 is PMH, and if the maintenance hole is identified as number 01 in that pathway, the next segment of the identifier would be PMH.01.

If the detail information on the subduct is its identification as A3, and if the qualifying information is the size of the subduct, for example 2", then the last segment of the identifier would be A3(2).

The complete identifier would then be:

[STE-1A]/[TEA-2B]-PMH.01.A3(2)

Example 2:

An equipment rack in a telecommunications room in a class 2 system that has a single building would be identified using this format:

fs-UUU.n

If the telecommunications room is identified as 1A, and the descriptor for a rack from table 3 is PRK, and the rack is identified as number 23, then the full identifier would be:

1A-PRK.23

Note that since there was no further detail or qualifying information about the rack, the d(q) portion of the identifier format was not used.

Example 3:

A 24-optical fiber cable owned by Hillsborough County School Board that connects John Harold High School to the school board's Wean Administration Complex would be identified using this format:

[c1-b1-fs1]/[c2-b2-fs2]-UUU.n.d(q)

If the John Harold High School campus is identified as JHS and the entrance facility in Building 101 where the cable is terminated is identified as 101-1A, then the first segment of the identifier would be [JHS-101-1A].

Likewise, if the Wean Administration Complex is identified as WAC, and the entrance facility in Building 102 is identified as 102-2B, then the second segment of the identifier would be [WAC-102-2B].

The descriptor for an optical fiber cable from table 3 is FCA. If this cable is identified as cable 02, the detail information refers to the 24<sup>th</sup> optical fiber, and the qualifying information is that the fiber is single-mode, then the complete identifier for the cable would be:

[JHS-101-1A]/[WAC-102-2B]-FCA.02.24(sm)

Alternatively, if the School Board network manager needed only to identify the cable, the information in the last two fields (the reference to the 24<sup>th</sup> optical fiber and that it is single-mode) could be contained in the corresponding record.

**Table 3 - Optional identifiers associated with pathway, device, and space elements**

<b>Copper</b>	<b>Fiber</b>	<b>Wireless</b>	<b>Coax</b>
C – Copper	F – Fiber	W - Wireless	X – Coax
BF Block Field CA Cable CS Case CC Cross Connect FP Feed Pair HP House Pair MS Mechanical Splice PL Panel PT Port SP STP SH Sheath SN Section TM Termination UP UTP	CA Cable CS Case MM Multi-Mode FS Fusion Splice PL Panel PT Port SH Sheath SM Single-Mode SN Section TM Termination	BW Bandwidth CH Channel WT Wireless Tap	TP Tap (coax) SN Section TM Termination LG Leg

<b>Pathway</b>	<b>Devices</b>	<b>Spaces</b>
P – Pathway	A - Active Device	S - Space
BR Branch Splice BS Bridge Splice CB Cabinet CN Conduit CT Cable Tray FR Frame GB Ground Bar NT Node PB Pull Box PN Penetration RK Rack RR Ring Rung SL Sleeve SS Straight Splice ST Slot TY Tray  The following pathway elements can also be defined as spaces if the identifier is expressed in brackets along with a site/campus and/or building identifier.  MH Maintenance Hole HH Handhole BR Bridge TN Tunnel TP Telephone Pole DB Direct Buried locale SM Submerged locale EN Entrance VL Vault PE Pedestal RT Roof Top	CMR Camera CS Chassis CI Carrier ID AMP Amplifier ANL Analog DIG Digital DLR Dialer FAX Fax GBR Glass Break HNS Handset MDM Modem MIC Microphone MNT Monitor PAY Payphone PC1 PC RDR Reader RS Remote Shelf SF Shelf SNS Sensor SPK Speaker STK Strike STR Strobe TEL Telephone TTY Tele Type TV1 Television WLP Wall Phone	AP Access Point APS Access Provider Space CER Common Equipment Room CTR Common Telecommunications Room CO Central Office DM Demarcation (NI) ER Equipment Room NOC Network Operations Center SPS Service Provider Space SR Switch Room STAR Logical Center of the data network TER Telecommunications Entrance Room TR Telecommunications Room WTRS Wireless Transmission and Reception Space WS Workstation Location SZ Serving Zone RO Repeater Office

## 10 COLOR-CODING IDENTIFICATION

### 10.1 General

Color-coding of cables, connectors, cords, jumpers, termination fields, labels, pathways, and other components may be used to identify the type, application, function, or position of a component within the infrastructure.

### 10.2 Color-coding of termination fields

#### 10.2.1 General

Color-coding of termination fields can simplify infrastructure administration and maintenance by making the structure of the cabling more intuitive.

Color codes may be used to identify a port or group of ports that are allocated to be used to deliver a specific service.

The color-coding of termination fields specified in this Standard is based on the topology of Cabling Subsystem 1, 2, and 3 cabling specified in ANSI/TIA-568-C.0.

#### 10.2.2 Color-coding of specific termination fields

If termination fields are color-coded, the coding shown in table 4 should be used. If a different color-coding scheme is used, it shall be consistent throughout the enterprise.

Cross-connections generally connect termination fields of different colors.

A summary and illustration of these recommendations are shown below in table 4 and figure 20.

**Table 4 - Example of termination field color-coding**

Termination Type	Color	Pantone #	Typical Application
demarcation point	orange	150C	central office connection
network connection	green	353C	user side of central office connection
common equipment	purple	264C	connection to PBX, mainframe computer, LAN, multiplexer
Cabling Subsystem 3	white		terminations of building Cabling Subsystem 3 cable connecting MC to ICs
Cabling Subsystem 2	gray	422C	termination of building Cabling Subsystem 2 cable connecting IC to HCs
campus cabling	brown	465C	termination of campus cable between buildings
Cabling Subsystem 1	blue	291C	terminations of Cabling Subsystem 1 cable in TSs
miscellaneous	yellow	101C	alarms, security, or energy management

Notes:

- a) Industry practice in Canada is to use white/silver (Pantone 877C) for common equipment terminations and purple for cabling subsystem 2 terminations.
- b) Industry practice in some areas reserves red for life safety alarm systems.

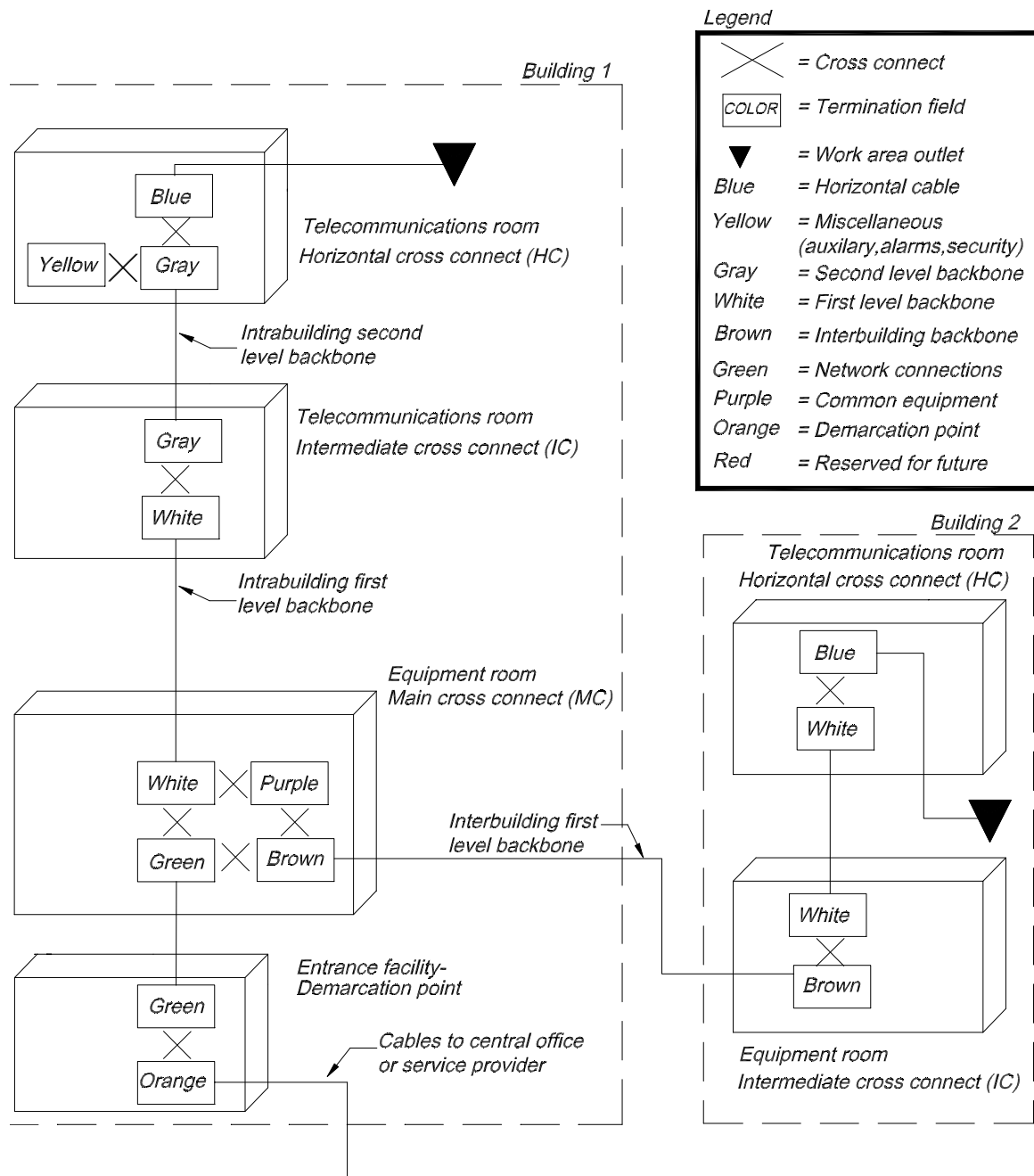

**Figure 20 - Example of color-coding of termination fields**

### **10.3 Color-coding in Cabling Subsystem 1 cabling**

#### **10.3.1 Cabling Subsystem 1 cabling components**

Color-coding may be used to differentiate Cabling Subsystem 1 cable runs, to identify services connected by patch cords, or to identify various services available in a work area outlet. To be of most value, such color-coding should be consistent throughout the system.

#### **10.3.2 Fiber cabling components**

##### **10.3.2.1 Fiber patch cords**

Most telecommunications circuits using fiber as a transmission medium require two fibers. Patch cords, equipment cords, and work area cords with simplex connectors should use different color connectors or strain relief boots to assist in maintaining proper polarity. Refer to ANSI/TIA-568-C.0 for recommendations on maintaining polarity.

##### **10.3.2.2 Fiber types and connector types**

Cabling systems may contain fiber with different core sizes, or different bandwidth specifications within the same core size. System operators should identify terminations by color to assist in maintaining compatibility when making connections.

Angled PC, or APC, fiber connectors are not compatible with other types, and system operators should identify these terminations by color to assist in maintaining compatible connections.

Refer to ANSI/TIA-568-C.3 for recommendations on color-coding multimode and single-mode connectors and adapters.

## **11 PERMANENT LABELS**

### **11.1 Visibility and durability**

The size, color, and contrast of all labels should be selected to ensure that the identifiers are easily read. Labels should be visible during normal maintenance of the infrastructure.

Labels should be resistant to the environmental conditions at the point of installation (such as moisture, heat, or ultraviolet light), and should have a design life equal to or greater than that of the labeled component.

### **11.2 Machine generation**

The text on labels shall be machine generated.

## **12 ADMINISTRATION SYSTEMS USING RECORDS, LINKAGES & REPORTS**

### **12.1 General**

Administration may be accomplished using traditional paper based methods, spreadsheets, databases, or specialized software. In addition to these systems, the functions of automated infrastructure management systems may be suitable for more complex installations, where staffing attributes make the use of automated systems more effective and efficient, and to meet regulatory compliance requirements (see clause 13).

Generally, these systems maintain a database of all infrastructure records described in this document. Records may also include linkages to related records that can be used to generate reports, provide tracing functions, and reduce duplication of information.

### **12.2 Records**

The administration system should include all records described in this standard, including the minimum elements for each record type as described in clauses 5 through 8. The administration system should also provide the capability to add user-defined information into each record. The record should include a time stamp indicating when it was last updated.

### **12.3 Linkages**

Linkages support the retrieval of information about the telecommunications infrastructure. Each required record type should define a primary indexing identifier to facilitate linkage between infrastructure identifiers and records. The primary indexing identifier for a cabling infrastructure element is typically the identifier of that element. Optional or user-defined record types should also define a unique primary indexing identifier.

### **12.4 Reports**

Reports are the means by which information about a telecommunications infrastructure is communicated. A report may consist of an individual record, a group of records, or selected portions of one or more records.

Administration systems shall provide reports listing all records containing a selected identifier and all information in those records, any desired subset of those records and the recorded information, or any desired union of such information. Paper-based or spreadsheet-based administration systems may require additional record-keeping beyond that described in clauses 5 through 8 to provide adequate reporting capabilities. For example, a drawing or graphical representation of the infrastructure would allow the operator to easily locate all telecommunications outlets in a given work area, even if they are connected to links originating from multiple telecommunications spaces.

### **12.5 Specialized software**

Specialized software may include standard databases and a variety of detection mechanisms to improve the accuracy and efficiency of telecommunications infrastructure administration. It may include technology to detect infrastructure changes and update the records. It should be capable of generating labels, or exporting the data to a device or program that will print them.

## **13 AUTOMATED INFRASTRUCTURE MANAGEMENT SYSTEMS**

### **13.1 General**

Automated infrastructure management systems should be implemented and maintained with an appropriate level of operational discipline, including an auditing regimen to ensure ongoing accuracy.

### **13.2 Core functions of automated infrastructure management**

The automated infrastructure management systems should be capable of:

- automatically documenting the infrastructure elements as described in this standard,
- providing a comprehensive record of all the connected equipment,
- facilitating easy trouble shooting,

- providing an automated method of discovering and documenting configuration of LAN and SAN switches,
- automatically discovering and documenting end devices that connect to the network.

The system should be fault tolerant (e.g., retention of information after a power outage).

The system should include the capability of automatically monitoring patch connections between connections with automated management, and of generating alerts and updating documentation when any of these patch connections are changed.

The system should be capable of automatically generating reports about the telecommunications infrastructure.

### **13.3 Auxiliary functions**

In addition to the core functions, other features of automated infrastructure management systems should be considered. Examples of these include:

1. Automatically discovering and tracking the physical location of the end devices that are connected to the infrastructure.
2. Integration with CAD-generated drawings or other types of building floor plans to allow for easier interactions with the infrastructure layouts and documentation.
3. Generating electronic work orders to support move – add – change (MAC) activities, or integrating with work order management systems in order to reduce the time required to implement network connectivity changes, and to deliver improved accuracy by minimizing possibilities of human errors.
4. Creation of text and labels as described in clause 10.
5. Managing and monitoring power and the operating environment.

### **13.4 Usage recommendations**

It is recommended that automated systems be used for:

- large or complex installations (administration classes 2, 3, and 4),
- where there is a shortage of staff,
- where the staff does not have the expertise to administer telecommunications cabling, and
- administration of remote sites.



## Annex A (informative) Identification of patch cords, equipment cords, and direct equipment-to-equipment cables

This annex is informative only and is not part of this Standard.

### A.1 Patch cord identifiers

Patch cords may be included in the administration system. The identifier of the patch cords in an administration system should have the same format as cables between ports, but use the back slash '\ ' instead of the forward slash.

#### A.1.1 TIA-606-A compatible format

The TIA-606-A compatible identifier format for patch cords is:

$$fs.x_1y_1-r_1:P_1 \setminus x_2y_2-r_2:P_2$$

where:

$fs$  = telecommunications space or computer room identifier as defined in 5.1.1. This portion of the identifier is optional for a class 1 administration system limited to a single equipment room or an administration system limited to a single computer room.

$x_1y_1-r_1$  = identifier for patch panel #1 on which the cable terminates, with format defined in 5.1.3

$P_1$  = port at the patch panel #1 on which the pairs terminate

$x_2y_2-r_2$  = identifier for patch panel #2 on which the cable terminates, with format defined in 5.1.3

$P_2$  = port at the patch panel #2 on which the pairs terminate.

The termination closest to the main cross-connect in the telecommunications cabling system hierarchy shall be listed first (before the backward slash). If the terminations are equal within the cabling system hierarchy, then the termination with the lesser alphanumeric identifier shall be listed first.

#### A.1.2 ISO/IEC compatible format

The ISO/IEC 14763-2-1 compatible identifier format for patch cords is:

$$+fs.x_1y_1+r_1:P_1 \setminus +x_2y_2+r_2:P_2$$

#### A.1.3 Implementation and labeling

See A.4 and A.5.

### A.2 Equipment cord identifiers

Equipment cords may be included in the administration system. The identifier of the equipment cords in an administration system should also use the back slash '\ ', with the connection to the structured cabling system first.

#### A.2.1 TIA-606-A compatible format

The TIA-606-A compatible identifier format for equipment cords is:

$$fs.x_1y_1-r_1:P_1 \setminus x_2y_2-e_2-s_2:P_2$$

where:

- $e_2$  = the identifier of the equipment to which the equipment cord terminates
- $s_2$  = the identifier of the slot, card, or module in equipment  $e_2$  to which the equipment cord terminates, this slot identifier is optional if the equipment does not require slot, card, or module identifiers to uniquely identify the port  $p_2$
- $P_2$  = port in equipment  $e_2$  slot  $s_2$  to which the equipment cord terminates.

The other fields are defined above in A.1.

### **A.2.2 ISO/IEC compatible format**

The ISO/IEC 14763-2-1 compatible identifier format for equipment cords is:

$$+fs.x_1y_1+r_1:P_1 \setminus +x_2y_2-e_2-s_2:P_2$$

### **A.2.3 Implementation and labeling**

See A.4 and A.5.

## **A.3 Direct equipment to equipment cable identifiers**

Direct cables between equipment may be included in the administration system.

### **A.3.1 TIA-606-A compatible format**

The TIA-606-A compatible identifier format for cables between equipment is:

$$fs.x_1y_1-e_1-s_1:P_1 \setminus x_2y_2-e_2-s_2:P_2$$

Where the fields are defined above in A.2.

If the network has a hierarchy, then the equipment closest to the network core shall be listed first; otherwise, the equipment with the lesser alphanumeric identifier  $e$  shall be listed first.

### **A.3.2 ISO/IEC compatible format**

The ISO/IEC 14763-2-1 compatible identifier format for cables between equipment is:

$$+fs.x_1y_1-e_1-s_1:P_1 \setminus +x_2y_2-e_2-s_2:P_2$$

### **A.3.3 Implementation and labeling**

See A.4 and A.5.

## **A.4 Labeling of patch cords, equipment cords, and direct equipment-to-equipment cables**

Patch cord, equipment cord, and direct equipment-to-equipment cable labeling should be accomplished via machine printed labels. Text on labels should be a font without serifs, upper case, and large enough to be easily read. Labels should be durably affixed to both ends of the cord or cable, conspicuously displayed just prior to the termination, and placed where they can be read without disconnecting the cord or cable.

Patch cords, equipment cords, and direct equipment-to-equipment cables shall be labeled with their identifiers if these cords and cables are administered by the cabling administration system.

Those patch cords, equipment cords, and direct equipment-to-equipment cables not administered by the cabling administration system should be labeled using the scheme described in A.5.

## A.5 Alternative scheme for labeling of patch cords, equipment cords, and direct equipment-to-equipment cables

Patch cords and equipment cords may be equipped with two labels on each end to identify the equipment or patch panels at both ends of the cord. The label closest to each connector identifies the equipment or patch panel to which that cord is attached. The next label toward the far-end of the cord identifies the equipment or patch panel at the other end of the cord. These labels should contain the following information:

- cabinet or rack identifier (the word “cabinet” or “rack” prior to cabinet or rack identifier is suggested),
- equipment or patch panel identifier (the word “panel” prior to panel identifier is suggested),
- port number or slot/port number (the word “port” prior to the port number is suggested).

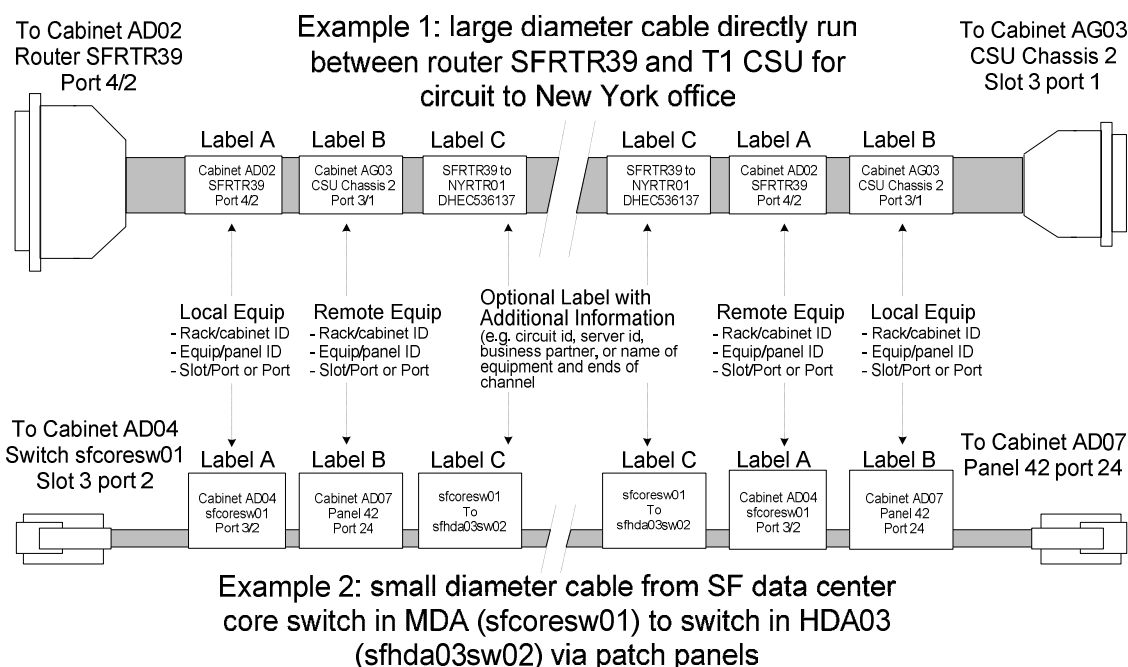

**Figure 21 – Equipment cord & patch cord labeling scheme**

If these labeling scheme is used, the four labels that should be installed on all patch cords and equipment cords are Labels A and B in figure 21 above. They are identical on both ends of the cord, but the order of the labels is reversed on each end because label A captures near-end connection information on the left of the figure, and far-end connection information on the right.

An optional third label – Label C in figure 21 - may be installed on each end of a patch cord or equipment cord to provide additional information regarding function of the connection. This additional information may be useful when tracing a connection that is routed through multiple patch panels. This optional label may include server name, business partner name, remote office name, circuit number, or name of equipment at each end of the channel. This third label is the same on both ends of the cord.

The labels should be placed in the order indicated in figure 21.

## Annex B (informative) Telecommunications grounding system identification example

In figure 22, the identifiers are blue and the telecommunications grounding system components are red.

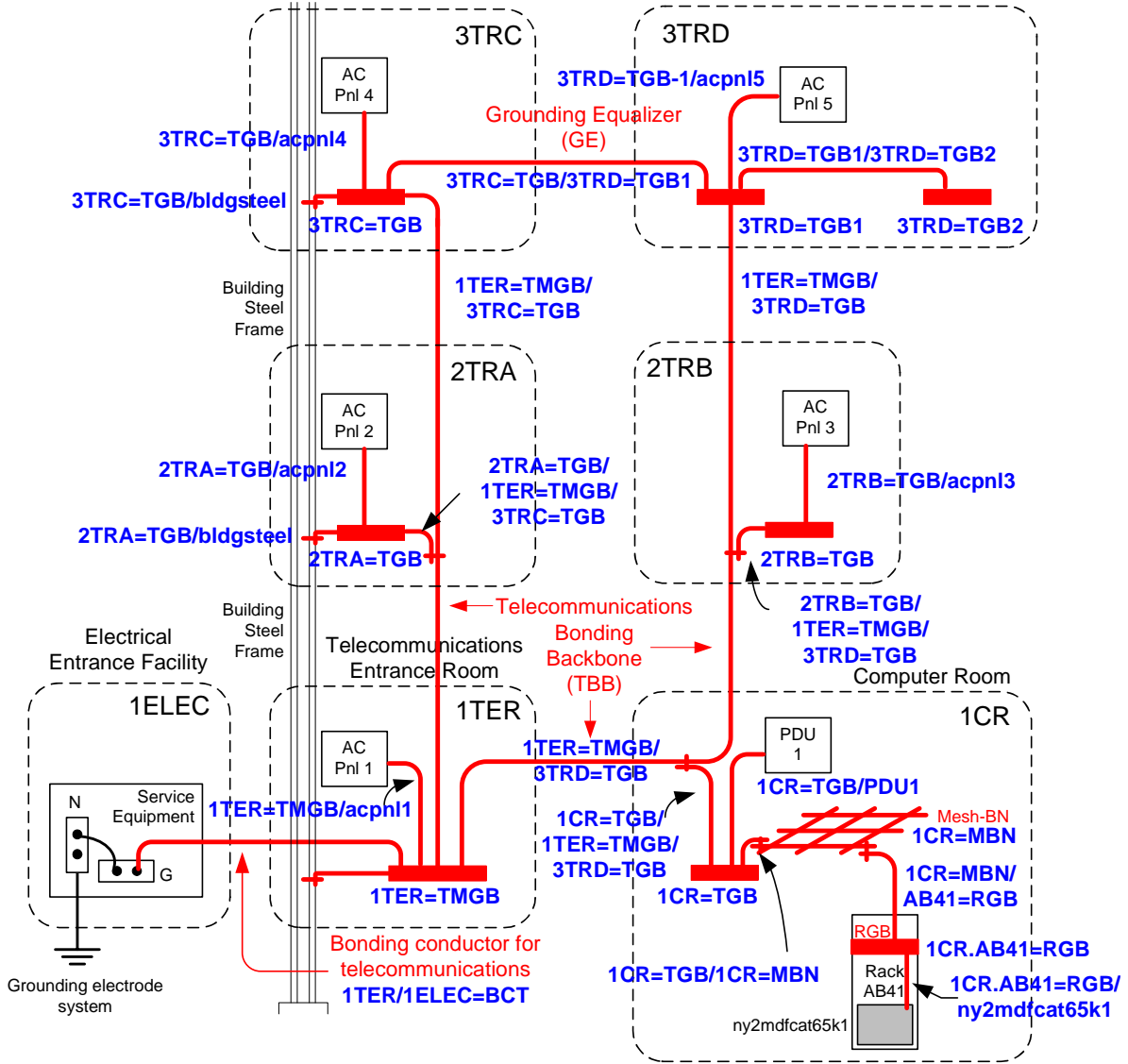

Figure 22 – Telecommunications grounding system labeling example

## **Annex C (informative) Graphical, symbology, and drawing elements of administration**

### **C.1 General**

This standard recommends the use of either the drawing standard specified in the U.S. National CAD standard (NCS) or the one described in this annex.

### **C.2 T-Series drawings**

T-series drawings are a set of drawings used in the construction industry to depict technology and telecommunications components and requirements. As telecommunications infrastructure becomes more integrated with other components of modern building design, the use of standardized T-series drawings becomes more important to the processes of designing, constructing, and renovating the buildings. The following symbols, line styles, layers and drawing organization are provided to assist the design professional with the presentation of the telecommunications requirements on scaled CAD drawings.

As this trend continues, more information will be shown on drawings for the purpose of constructing the telecommunications infrastructure and in turn these drawings will be used as key components in the administration of that telecommunications infrastructure. Therefore, the intent of this annex is to establish guidelines and recommendations that can serve as a foundation for consistent identification of telecommunications elements in a graphical or drawing format.

Building areas are shown from a plan view perspective (top down view) typically on a T1 drawing. The area in which the ER or building demarcation is located should be designated as building area A. Starting with "A" proceed around the building and assign the building area the next available designator, until all building areas are identified.

There are six types of drawings in the TIA-606-A backward-compatible drawing scheme. They are:

- T0** – Campus or site plans - exterior pathways and campus cabling.

T0 drawings show physical and logical connections from the perspective of an entire campus, such as actual building locations, exterior pathways and campus cabling on plan view drawings, major system nodes, and related connections on the logical system drawings. An example of a T0 drawing level is shown in figure 30 below. Examples of T0 line styles are shown in figure 23. Examples of T0 symbols are shown in figure 25, figure 26, and figure 27.

- T1** – Layout of complete building per floor - building area/serving zone boundaries, Cabling Subsystem 1, 2, and 3 pathways.

T1 drawings show the layout of complete building per floor. The drawing indicates location of building areas, serving zones, telecommunications rooms, access points, pathways and other systems that need to be viewed from the complete building perspective. An example of a T1 drawing level is shown in figure 31. Examples of T1 line styles are shown in figure 23. T1 pathway drawing notes are shown in figure 24. Examples of T1 symbols are shown in figure 26 and figure 27.

- T2** – Serving zones/building area drawings - drop locations and cable ID's.

T2 drawings show a building area or serving zone. These drawings show drop locations, telecommunications rooms, access points and detail call outs for common equipment rooms and other congested areas. An example of a T2 drawing level is shown in figure 32. Examples of T2 symbols are shown in figure 28. T2 general pathway conditions are listed in figure 24.

- T3** – Telecommunications rooms - plan views - tech and AMEP /elevations - racks and wall elevations.

T3 drawings provide telecommunications room details. These drawings indicate technology layout (racks, ladder-racks, etc.), mechanical/electrical layout, rack elevations, and backboard elevations. They may also be an enlargement of a congested area of T1 or T2. An example of a T3 drawing level is shown in figure 33. Examples of T3 symbols are shown in figure 29.

- T4** – Typical detail drawings - faceplate labeling, firestopping, ADA, Safety, DOT, etc.

T4 drawings provide details of symbols and typical components such as faceplate labeling, faceplate types, installation procedures, racking, and raceways.

- T5** – Schedules.

Schedules (spreadsheets) to show information for cut-overs and cable plant management.

### C.3 Layers

Table 5 provides recommendations for the TIA-606-A backward-compatible scheme for layer guidelines, line types, and colors.

**Table 5 - Layers, element descriptions, colors, and line types**

LAYER	DESCRIPTION	COLOR	LINETYPE
0		7	Continuous
*A-asbt-info	asbestos info	7	Continuous
*A-grid	planning grid	5	Center
A-anno-ttlb	border and title block	7	Continuous
A-clng	ceiling info	7 (hatch)	Continuous
A-door	doors	165	Continuous
A-eqpm-fixt	lab mill work	3	Continuous
A-flor-evtr	elevators	54	Continuous
A-flor-fixt	plumbing fixtures	230	continuous
A-flor-iden	room numbers	1	continuous
A-flor-strs	stairs	54	continuous
A-furn	furniture	200	continuous
A-glaz	windows	1	continuous
A-roof	roof info	120	continuous
A-wall	walls	7	continuous
E-lite	lighting	114	continuous
E-powr	power	114	continuous
E-powr-eqpm	power equipment	114	continuous
M-hvac	HVAC system	1	continuous
T-aerl-copp	aerial copper	30	hidden
T-aerl-fibr	aerial fiber	6	hidden
T-anno-keyn	details, reference, key notes	1	continuous
T-anno-note	general/drawing notes	7	continuous
T-anno-text	plan info	7	continuous
T-anno-ttlb	T series border	1	continuous
T-bkbn-comp	backboard and components	92	continuous
T-bkbn-coax-text	backbone coax	7	coax backbone
T-bkbn-cond-text	backbone conduit	6	continuous
T-bkbn-cppr-text	backbone copper	4	copper backbone
T-bkbn-fibr-cond	backbone fiber conduit	5	continuous
T-bkbn-fibr-text	backbone fiber	94	fiber backbone
T-bkbn-thck	backbone thicknet	4	thicknet
T-cabl	cabletray	30	cable tray
T-cabl-supp	cable support	30	continuous
T-card	card access	7	continuous
T-clip	clip boundary	7	continuous
T-clok	clock system	94	continuous
T-comp	workstations	150	continuous
T-drop-blnc	drop-blank	14	continuous
T-drop-exst	drop-existing	30	continuous
T-drop-mac	drop-mac	241	continuous
T-drop-prjA	drop-project A	241	continuous
T-drop-prjB	drop-project B	34	continuous
T-drop-prjC	drop-project C	220	continuous
T-drop-prjD	drop-project D	162	continuous
T-drop-reno	drop-renovation	45	continuous
T-intr-cond-fibr	interior conduits fiber	94	fiber backbone













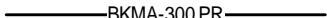
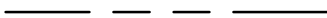
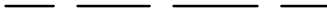

## ANSI/TIA-606-B

T-lgcy-bond	legacy boundary lines	1	legacy boundary
T-lgcy-thck	legacy thicknet	4	legacy thicknet
T-modm	modem	24	continuous
T-path-extr	exterior pathways	7	continuous
T-pbx1	PBX	165	continuous
T-prnt	printer	24	continuous
T-race-surf	surface raceways	20	continuous
T-rack-comp	racks and components	30	continuous
T-rack-lddr	ladder rack	30	ladderrack
T-reno	renovation hatching	7 (hatch-ansi 31-1/8" plot)	continuous
T-serv-bond	serving zone boundary lines	5	servzone boundary
T-slev-int	interior sleeve	210	continuous
T-soun	sound/PA system	7	continuous
T-util	utility pole	1	continuous
T-vdeo	video	170	continuous
T-view	viewport	7	continuous

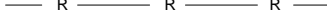

#### C.4 Line styles, pathway conditions, and drawing notes

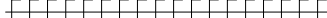
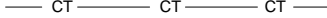
See figure 23 for the recommended TIA-606-A backward-compatible T0 and T1 drawing line styles and figure 24 for the recommended format for pathways conditions and drawing notes.

	Existing cable
	Proposed cable
	Future cable
	To be removed
	Gauge, type and size
	Boundary lines
	Legacy boundary lines
	Backbone copper conduit
	Backbone fiber conduit
	Backbone conduit
	Optical fiber backbone
	Copper backbone
	COAX backbone
	Interior pathways ring run
	Interior pathways strand
	J Hooks
	Cable tray
	Cable tray (size as indicated)
	Ladder rack

**Figure 23 – T0 and T1 line styles**

T2-GENERAL PATHWAY CONDITIONS

---

FW	FISHABLE WALL
SC	SURFACE BOX TO CEILING
SH	SURFACE BOX TO HALL
SF	SURFACE BOX TO FLOOR
CC	CONDUIT TO CEILING
CR	CONDUIT TO TELECOMMUNICATIONS ROOM
CH	CONDUIT TO HALL
CF	CONDUIT TO FLOOR
CT	CONDUIT TO TRAY
GC	4000/6000 RACEWAY TO CEILING
GH	4000/6000 RACEWAY TO HALLWAY
ST	SURFACE TO CABLETRAY

T1-PATHWAY DRAWING NOTES

---

⑥0	700 METAL RACEWAY
⑥1	LD3
⑥2	LD5
⑥3	LD10
⑥4	3/4" CONDUIT
⑥5	1" CONDUIT
⑥6	1-1/4" CONDUIT
⑥7	4000 RACEWAY
⑥8	6000 RACEWAY
⑥9	1 GANG MUD RING WITH INSIDE SQUARE CORNERS
⑦0	2 GANG MUD RING WITH INSIDE SQUARE CORNERS
⑦1	MP1 PLATE
⑦2	MP2 PLATE

**Figure 24 - Pathway conditions and drawing notes**

### C.5 Symbols

See figure 25 through figure 29 for recommended symbols for T-0, T-1, T-2 and T-3 drawings.

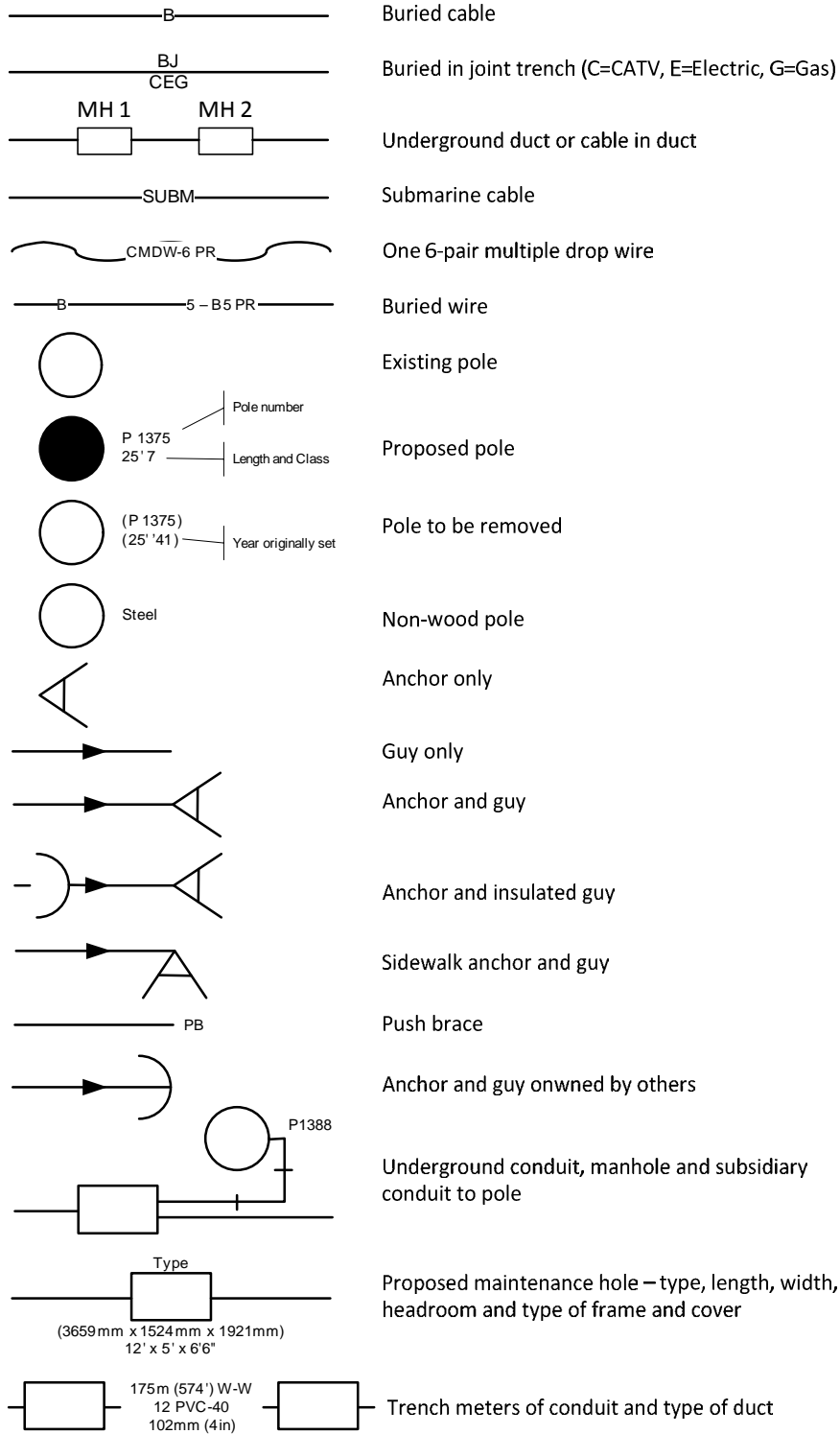

Figure 25 – T0 symbols

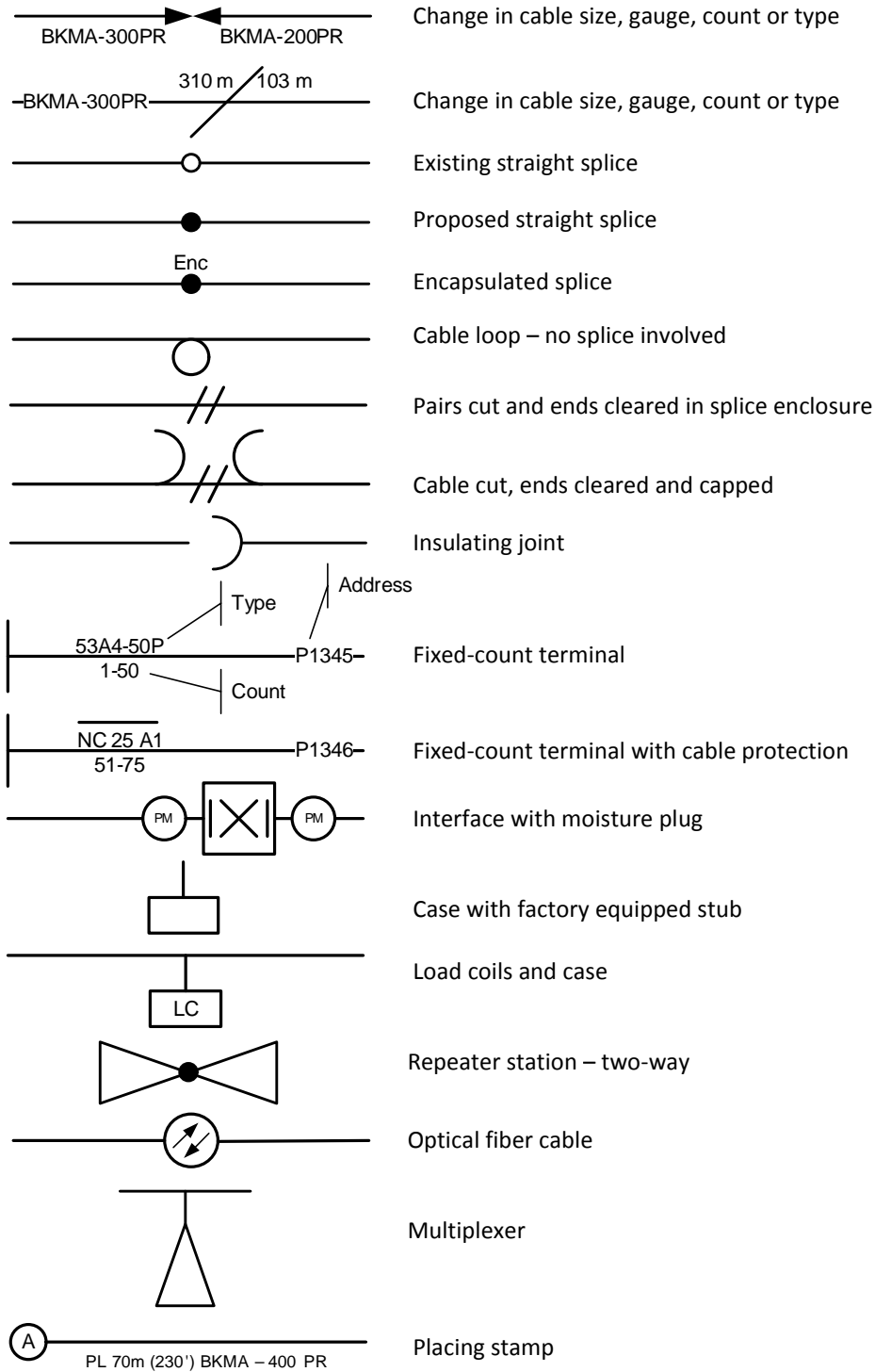
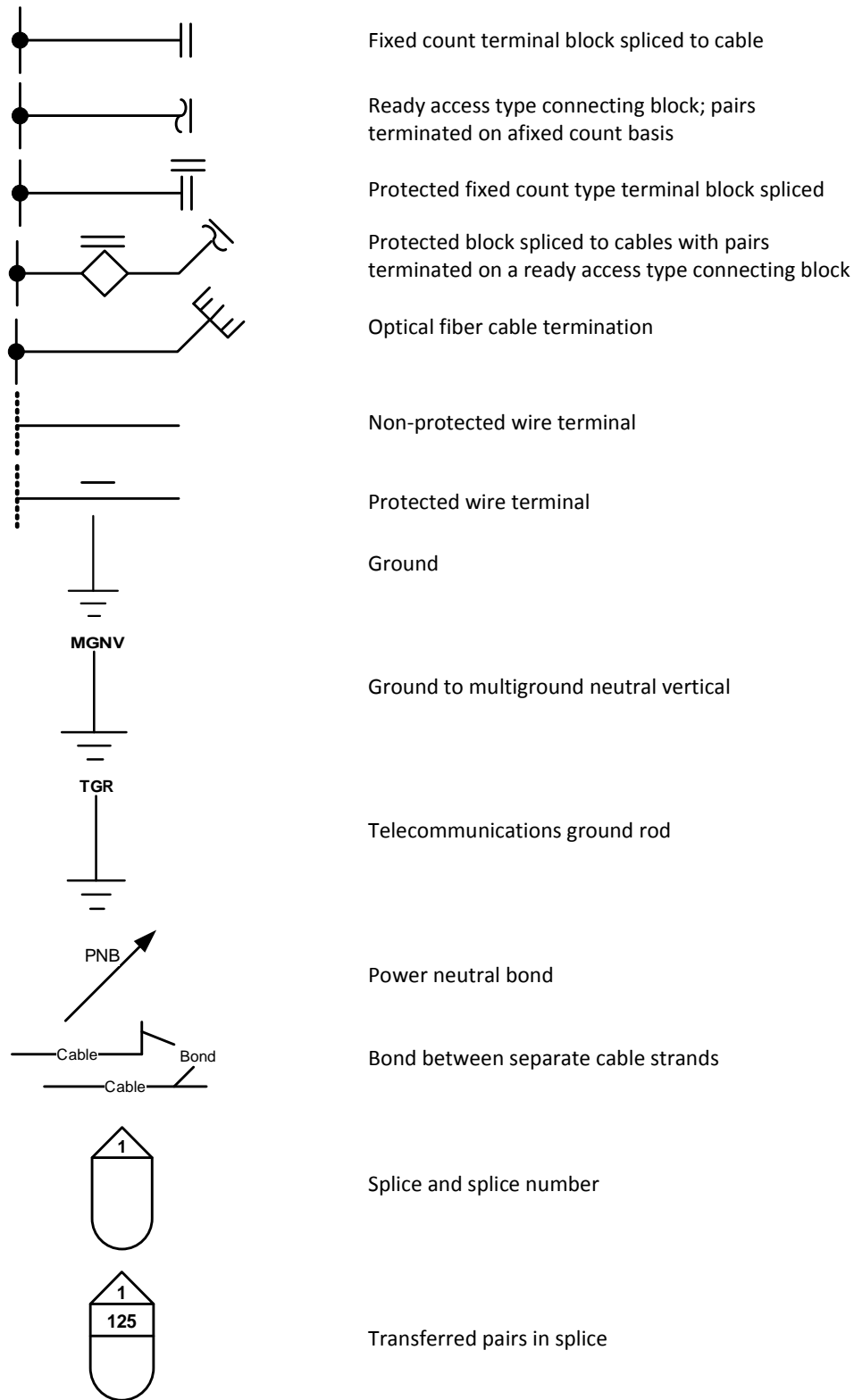

































Figure 26 – T0 & T1 symbols





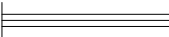

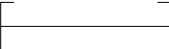

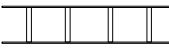
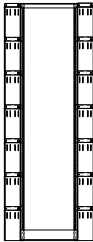

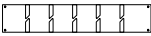



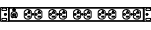



**Figure 27 – Additional T0 & T1 symbols**

ANSI/TIA-606-B

-  Drop location
-  Existing location to be rewired
-  Public phone
-  Wall phone
-  Secure wall phone
-  Security panel
-  Emergency phone
-  Drop location with blank plate
-  Future phone location
-  Ceiling mounted location
-  Access Point
-  Fire alarm panel
-  Security or fire alarm dialer
-  Floor mounted
-  Ceiling access panel
-  Ceiling access panel
-  Lightning protection
-  Electronic door operator
-  Electronic motorized door activation motion detector
-  Pushbutton, 46" AFF (or as specified)
-  Television location
-  Television location wired to call system
-  Copier network box 18" AFF
-  Electro-magnetic door lock
-  Electro-magnetic door strike  
With monitoring contact
-  Magnetic door switch
-  Security system card reader
-  Motion detector
-  Security system magnetic lock key  
bypass switch (46" AFF or as specified)
-  Closed circuit surveillance  
camera (90" AFF or as specified)
-  Security system keypad entry  
station (46" AFF or as specified)
-  Closed circuit surveillance TV  
Monitor (46" AFF or as specified)

**Figure 28 - T2 symbols**

	Twist lock receptacle
	Thermostat
	120 volt receptacle
	Ground bar
	Electrical panel
	Strip light
	Vertical sleeve (size as indicated)
	Horizontal sleeve (size as indicated)
	Conduit (size as indicated)
	Ladder rack
	2m (7 foot) equipment rack (front view) with cable managers
	2m (7 foot) equipment rack (top view) with cable managers
	Cable manager
	Patch panel
	Fiber distribution cabinet (size as indicated)
	Fiber splice cabinet
	Power strip
	IDC distribution block

**Figure 29 - T3 symbols**





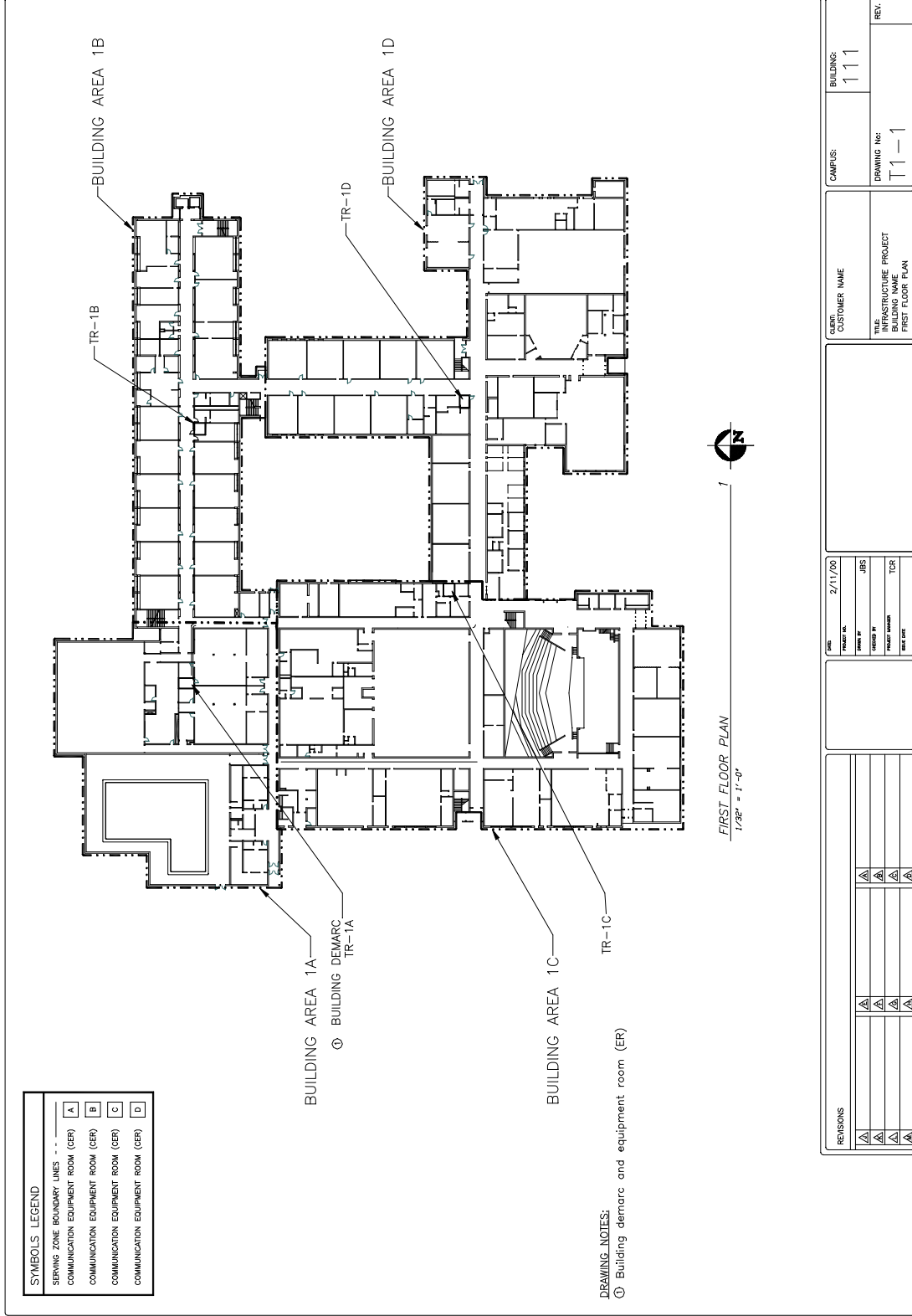

Figure 31 - Example of T1 drawing level

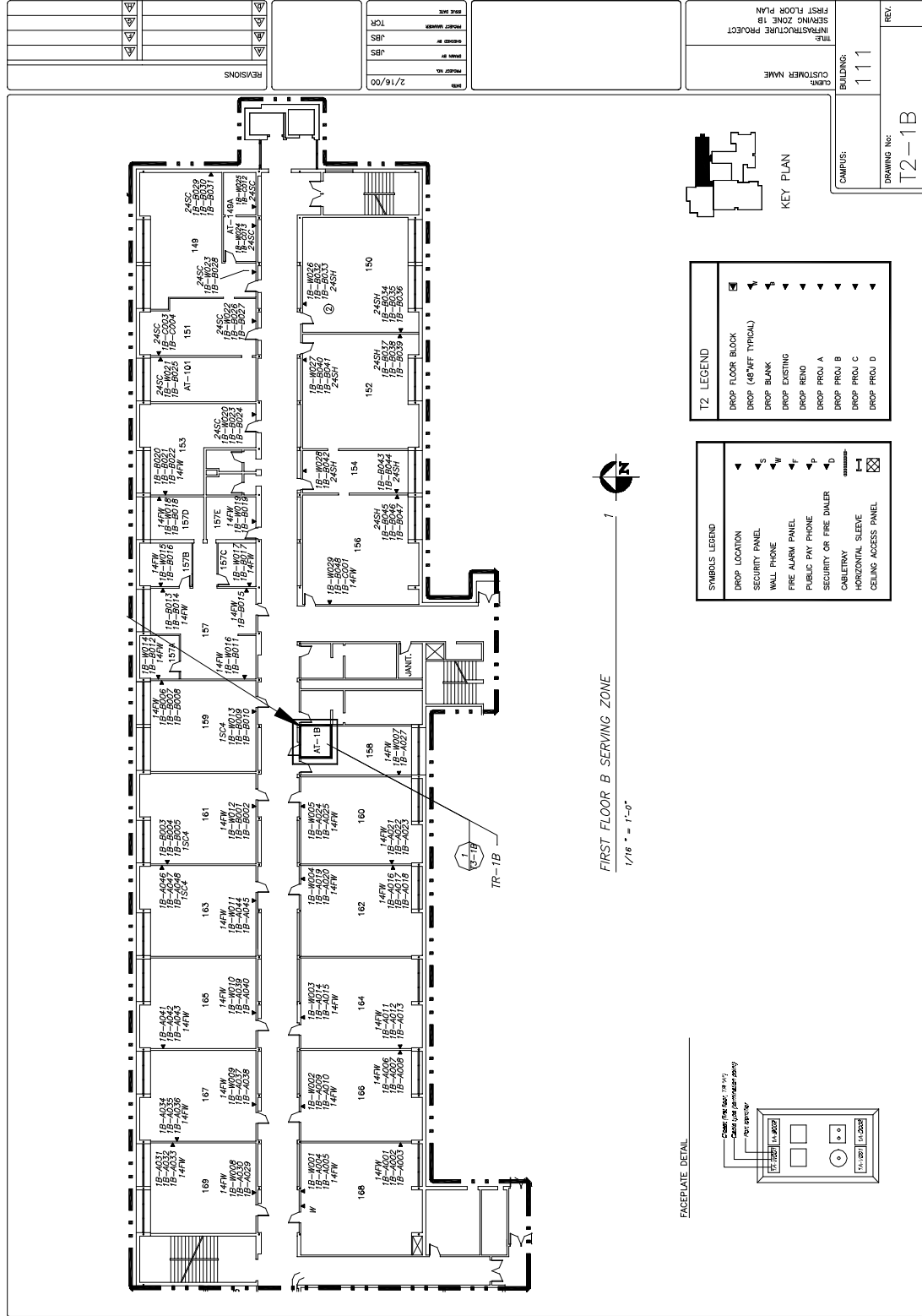
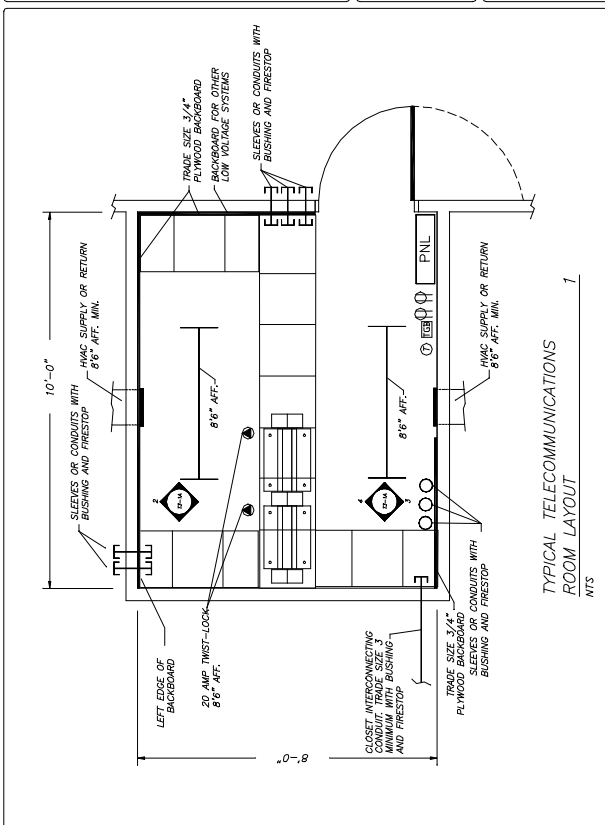
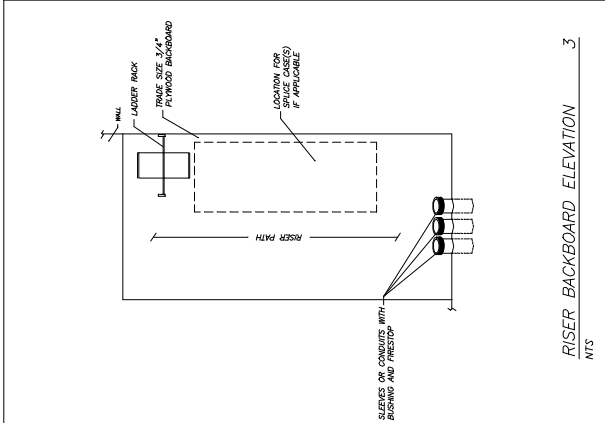
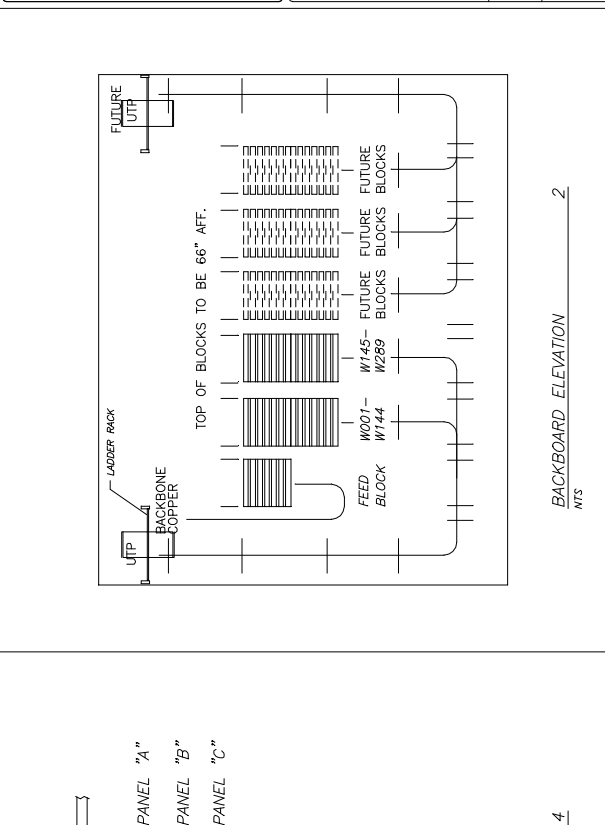
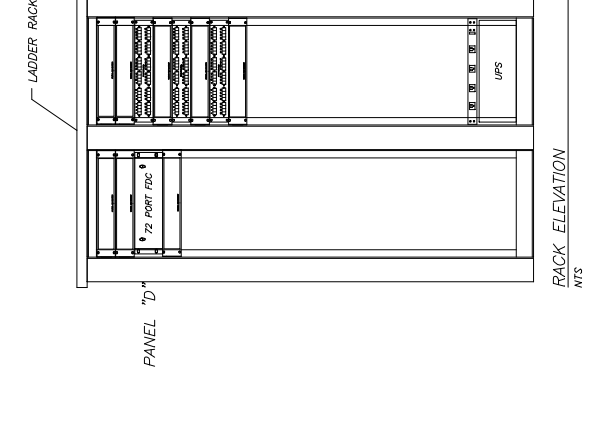
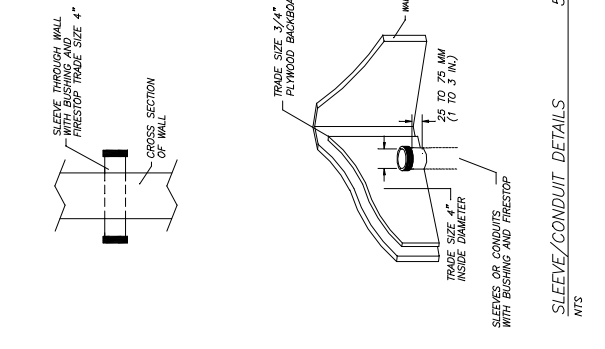

Figure 32 - Example of T2 drawing level

T3 LEGEND	
	20amp TWIST-LOCK RECEPTACLE
	THERMOSTAT
	110v CONVENIENCE RECEPTACLE
	GROUND BAR
	ELECTRICAL PANEL
	4' STRIP LIGHT
	4" VERTICAL SLEEVES
	4" HORIZONTAL SLEEVES
	CONDUIT (SIZE AS INDICATED)
	LADDER RACK
	7' EQUIPMENT RACK (TOP VIEW) WITH CABLE MANAGERS
	7' EQUIPMENT RACK (FRONT VIEW) WITH CABLE MANAGERS
	CABLE MANAGER
	48 PORT PATCH PANEL
	FIBER DISTRIBUTION CABINET (SIZE AS INDICATED)
	POWER STRIP (RACK MOUNTED)
	IDC BLOCK (300 PAIR TYPICAL)



DATE	
PROJECT NUMBER	
CHECKED BY	
DRAWN BY	
PROJECT NO.	
TYPE	



CLIENT	
BUILDING No.	
DRAWING No.	T3-1A
MTS	TELECOMMUNICATIONS ROOM

Figure 33 - Example of T3 drawing level

## Annex D (informative) Bibliography and References

This annex is informative only and is not part of this Standard.

This annex contains information on the documents that are related to or have been referenced in this document. Many of the documents are in print and are distributed and maintained by national or international standards organizations. These documents can be obtained through contact with the associated standards body or designated representatives. The applicable electrical code in the United States is the National Electrical Code.

- ANSI/IEEE C2-207, *National Electrical Safety Code®*
- ANSI/NFPA 70-2011, *National Electrical Code© (NEC©)*
- ANSI/TIA-598-C-2005, *Optical Fiber Cable Color-coding*
- BICSI *Telecommunications Distribution Methods Manual (TDMM)*, 12<sup>th</sup> Edition, 2009
- BICSI *Information Transport Systems Installation Methods Manual (ITSIMM)*, 6<sup>th</sup> Edition, 2010
- BICSI *Outside Plant Design Reference Manual (OSPDRM)*, 5<sup>th</sup> Edition, 2010

The organizations listed below can be contacted to obtain reference information.

### ANSI

American National Standards Institute (ANSI)  
25 West 43<sup>rd</sup> Street, 4<sup>th</sup> floor  
New York, NY 10036  
USA  
(212) 642-4900  
[www.ansi.org](http://www.ansi.org)

### BICSI

BICSI  
8610 Hidden River Parkway  
Tampa, FL 33637-1000  
USA  
(800) 242-7405  
[www.bicsi.org](http://www.bicsi.org)

### CSA

Canadian Standards Association (CSA)  
5060 Spectrum Way, Suite 100  
Mississauga, Ontario  
Canada, L4W 5N6  
(416) 747-4000  
[www.csa.ca](http://www.csa.ca)

### IEC

International Electrotechnical Commission (IEC)  
PO Box 131  
3 rue de Varembe

CH - 1211 Geneva 20  
Switzerland  
+41 22 919 02 11  
[www.iec.ch](http://www.iec.ch)

IEEE

The Institute of Electrical and Electronic Engineers, Inc (IEEE)  
10662 Los Vaqueros Cir  
P.O. Box 3014  
Los Alamitos, CA 90720-1264  
USA  
(714)-821 8380  
[www.ieee.org](http://www.ieee.org)

ISO

International Organization for Standardization (ISO)  
1, ch. de la Voie-Creuse  
Case Postale 56  
CH-1211 Geneva 20  
Switzerland  
+41 22 749 01 11  
[www.iso.org](http://www.iso.org)

NFPA

National Fire Protection Association  
1 Batterymarch Park  
Quincy, MA 02169-7471  
USA  
(617) 770-3000  
[www.nfpa.org](http://www.nfpa.org)

TIA

Telecommunications Industry Association (TIA)  
2500 Wilson Blvd., Suite 300  
Arlington, VA 22201-3836  
USA  
(703) 907-7700  
[www.tiaonline.org](http://www.tiaonline.org)





## **THE TELECOMMUNICATIONS INDUSTRY ASSOCIATION**

TIA represents the global information and communications technology (ICT) industry through standards development, advocacy, tradeshows, business opportunities, market intelligence and world-wide environmental regulatory analysis. With roots dating back to 1924, TIA enhances the business environment for broadband, mobile wireless, information technology, networks, cable, satellite and unified communications.

TIA members' products and services empower communications in every industry and market, including healthcare, education, security, public safety, transportation, government, the military, the environment and entertainment. TIA co-owns the SUPERCOMM® tradeshow and is accredited by the American National Standards Institute (ANSI).



HEADQUARTERS  
2500 Wilson Boulevard  
Suite 300  
Arlington, VA 22201-3834  
+1.703.907.7700  
+1.703.907.7727 (fax)

[tiaonline.org](http://tiaonline.org)