

# Dengue virology and diagnosis

**Dr. Behzad Khansarinejad**

*Associate professor of Medical Virology*

*Arak University of Medical Sciences*

- Family **Flaviviridae**
- Genus **Flavivirus**.

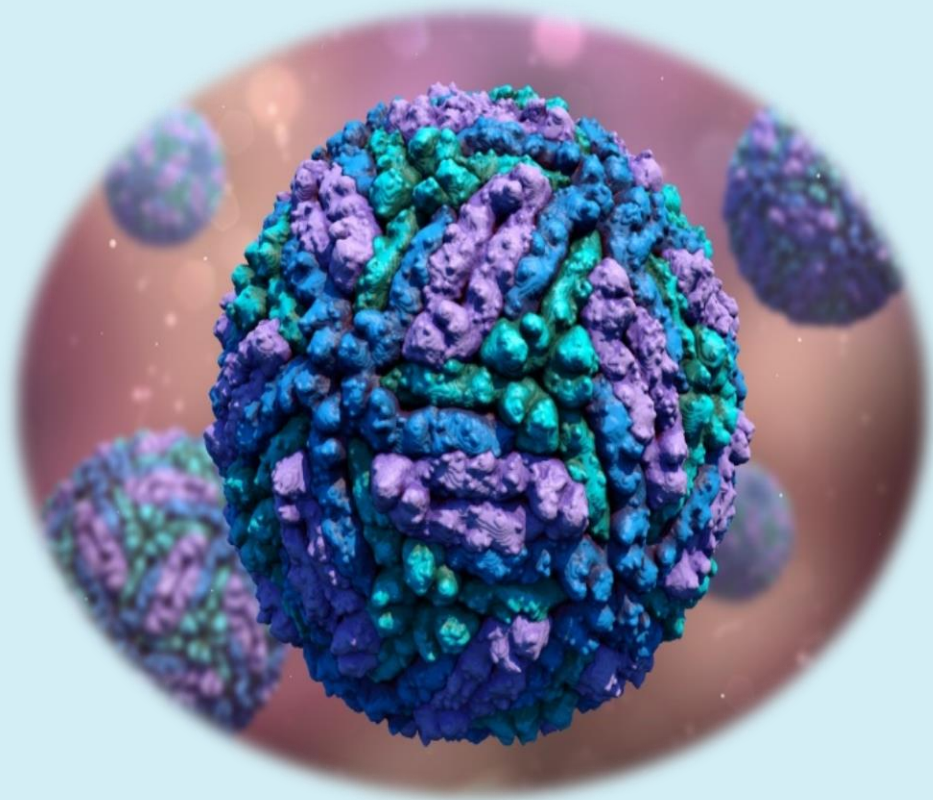
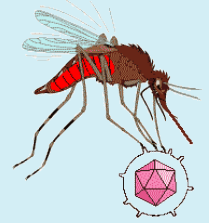

Virus	Serocomplex	Clade	Cluster
West Nile	Japanese encephalitis	XIV	Mosquito-borne
Kunjin			
Japanese encephalitis			
Murray Valley encephalitis			
St Louis encephalitis		XI	
Dengue-1	Dengue	IX	
Dengue-3			
Dengue-2			
Dengue-4			
Yellow fever	None	VII	
Central European encephalitis	Tick-borne encephalitis	IV	Tick-borne
Far Eastern encephalitis			
Powassan			
Dakar bat	None	III	No vector

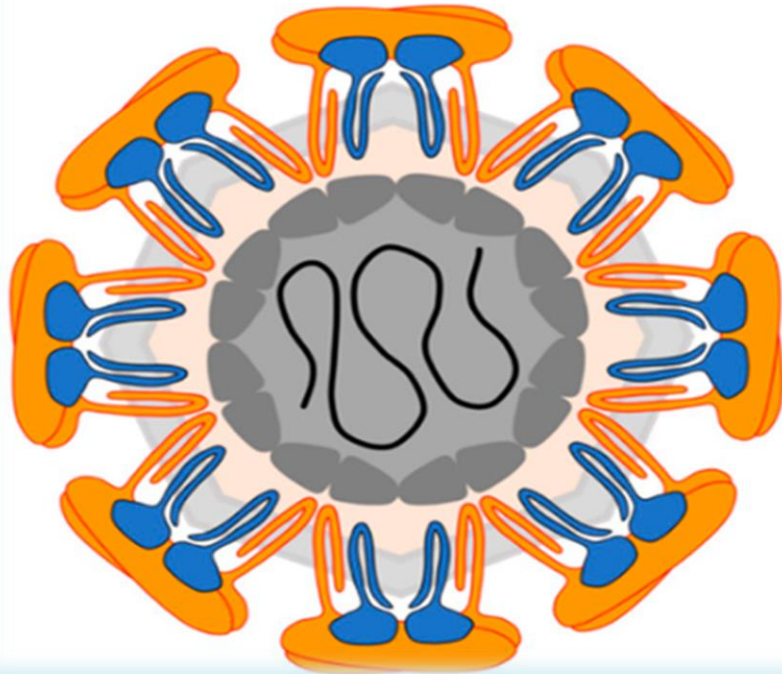
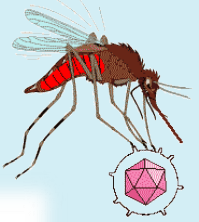

**Envelope (E) protein**



**Membrane (M) protein**



**Capsid (C) protein**



**Genomic RNA**

# Genomic Properties

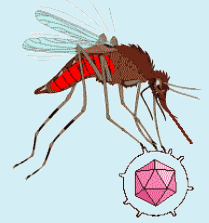

The Dengue genome is ~11 kb in length which is translated single complete polyprotein, with RNA helicase and RNA-dependent RNA polymerase (RdRp).

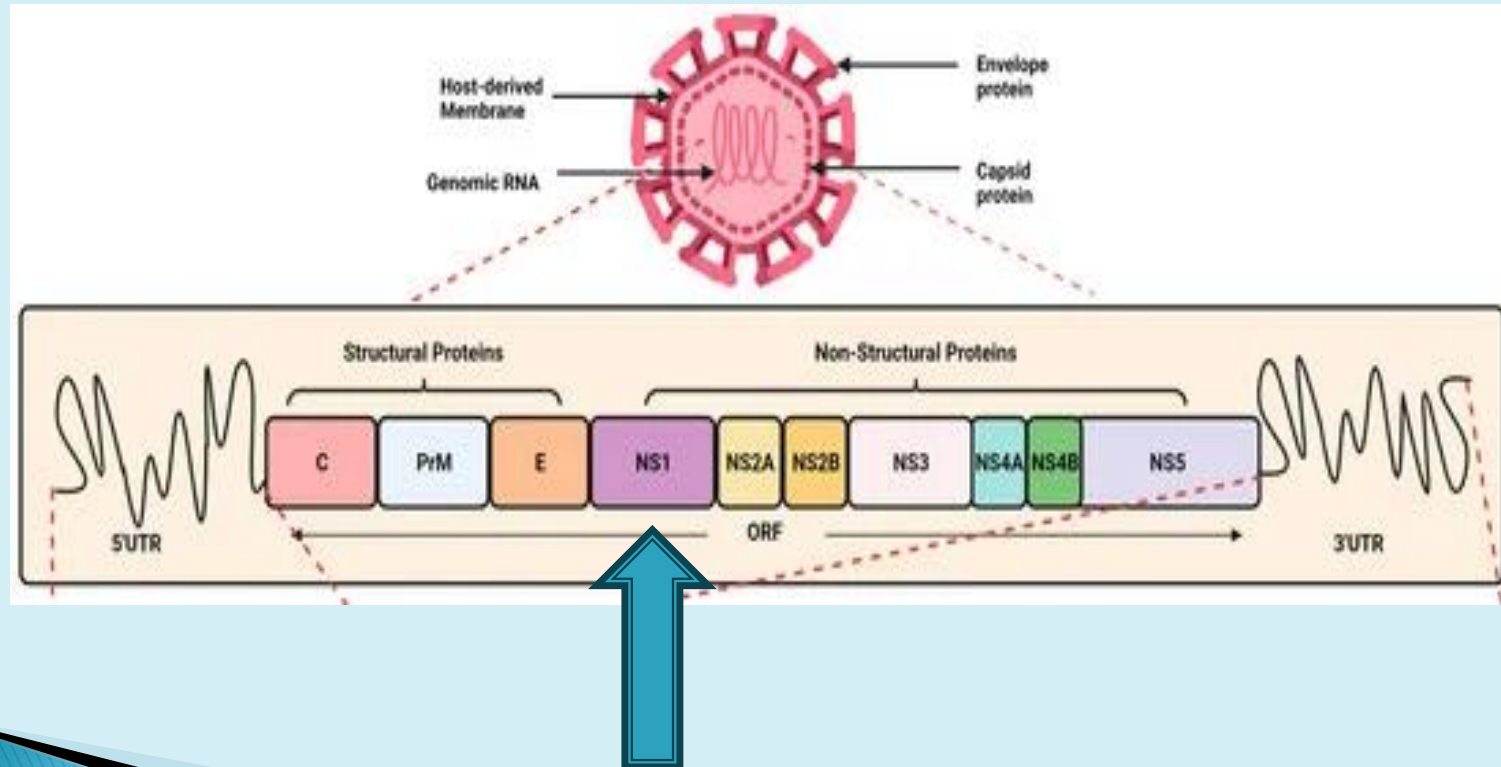

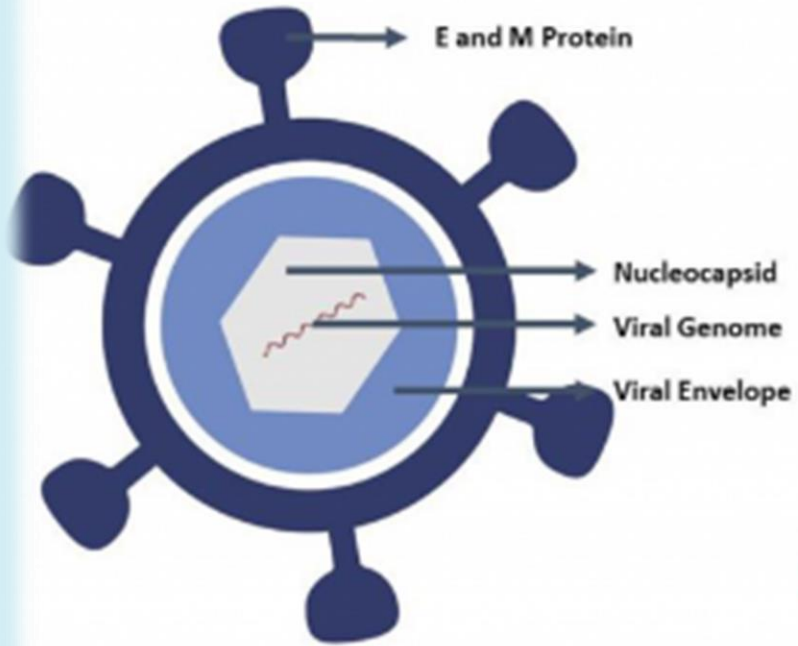

**DENV**

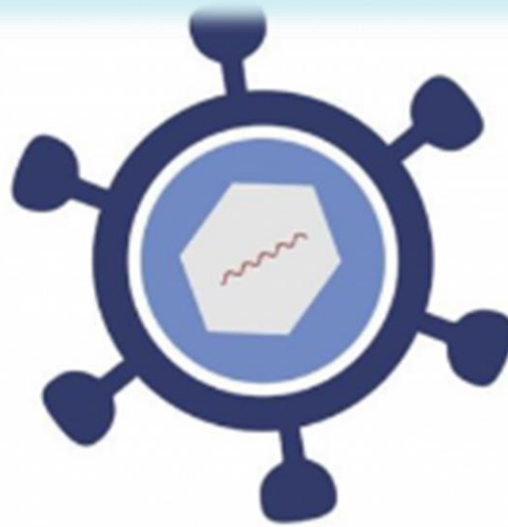

**DENV Serotype 1**

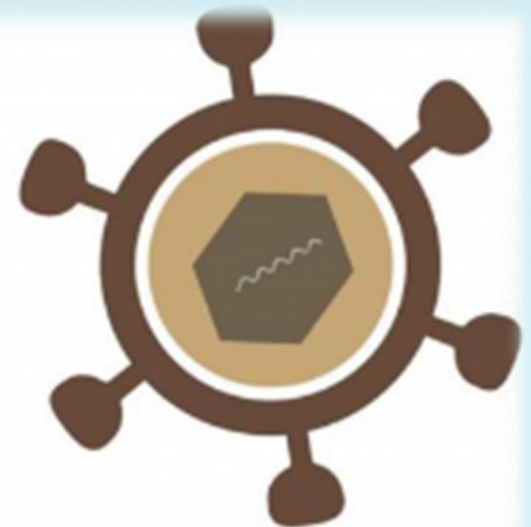

**DENV Serotype 2**

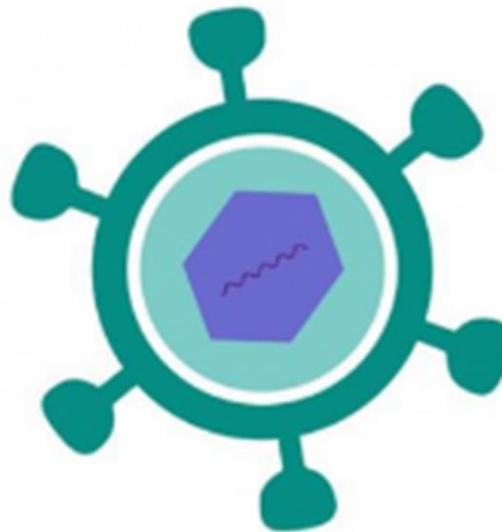

**DENV Serotype 3**



**DENV Serotype 4**

# Distribution of DENV sequences (NCBI)

2000 - 2014

15 year(s)

Data term : 1944 - 2016  
Last updated : 2016/05/13  
Download [xlsx](#) / [csv](#)

- All
- Serotype 1
- Serotype 2
- Serotype 3
- Serotype 4

## Serotype

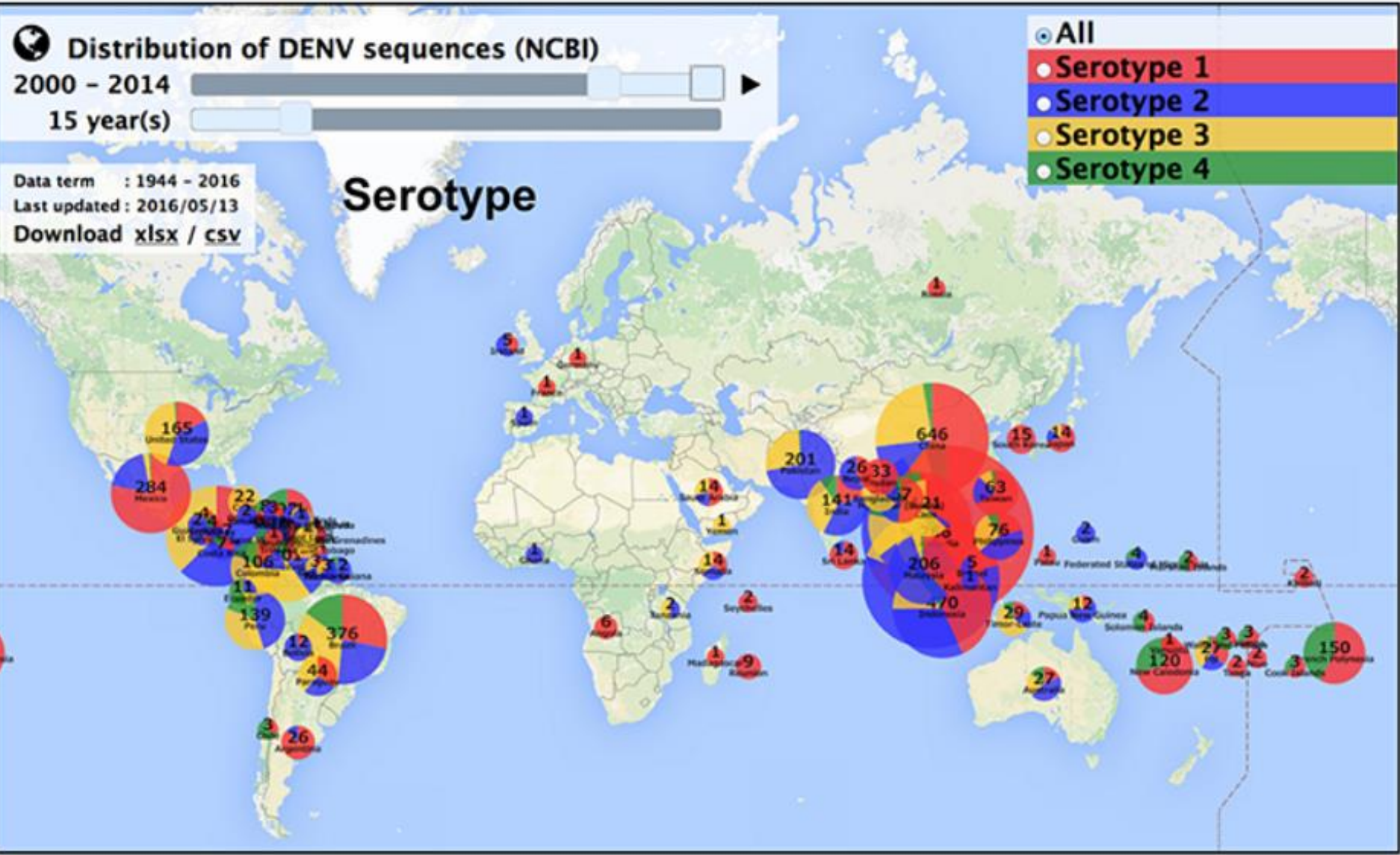

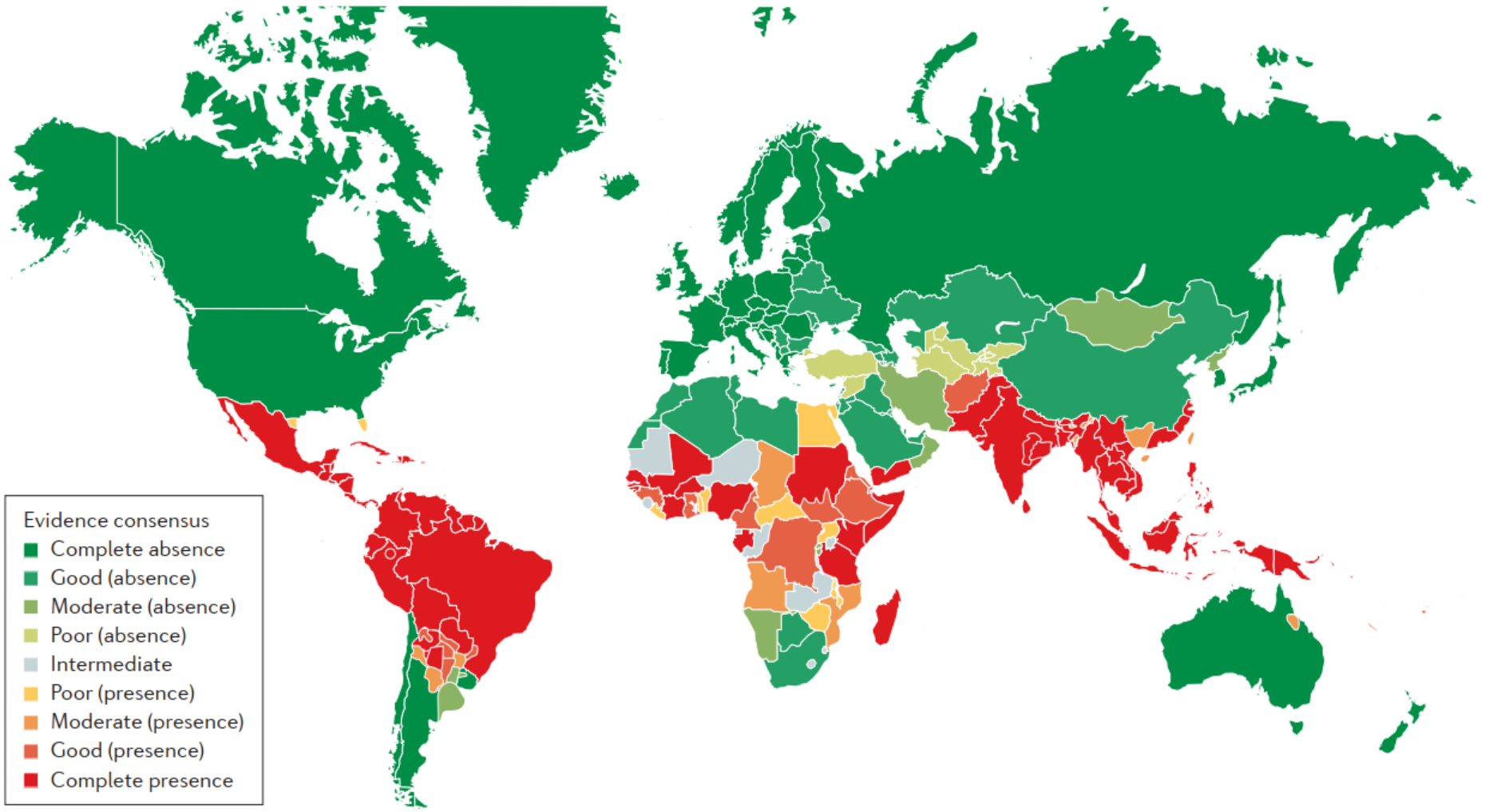

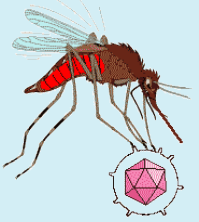

Sylvatic/enzootic

Epidemic

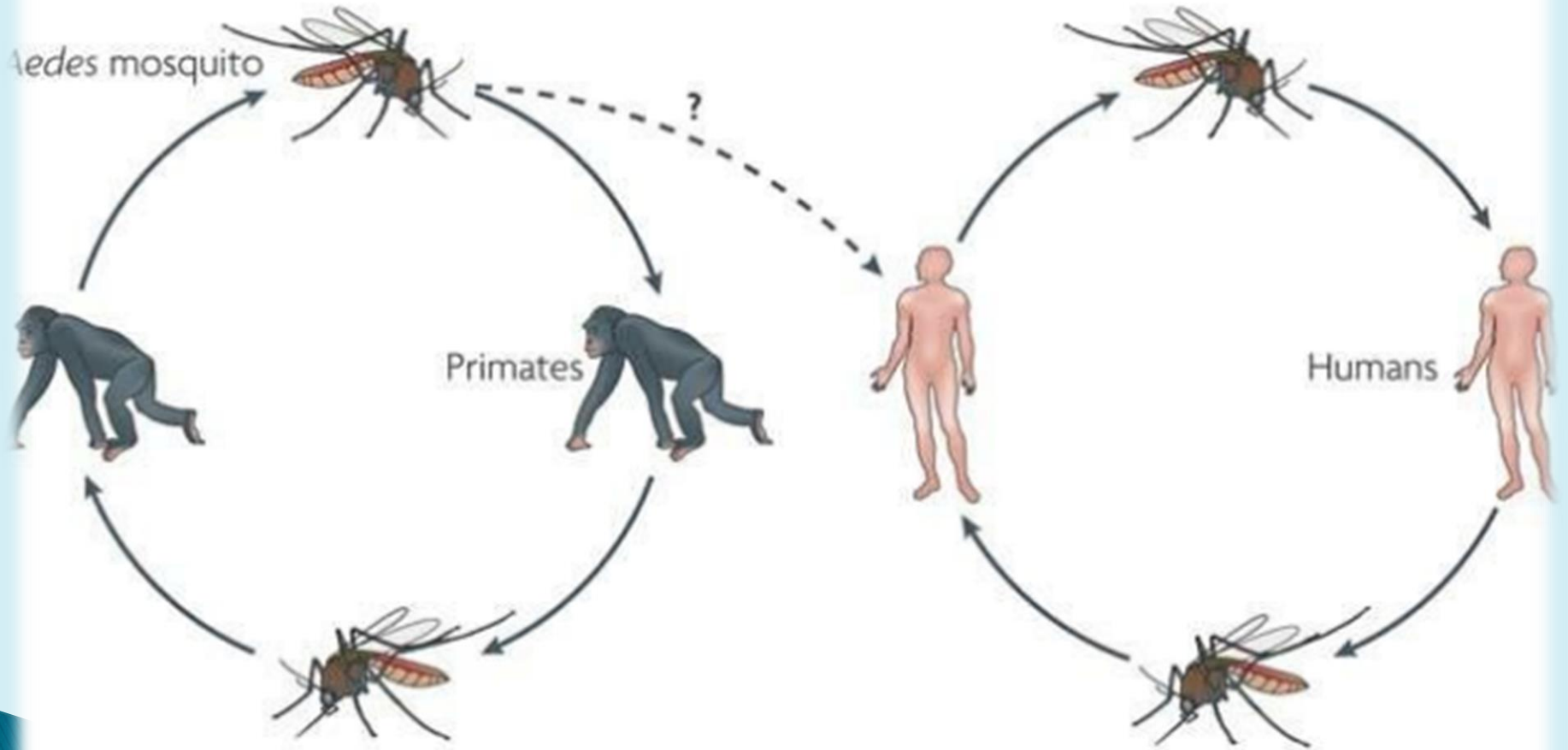



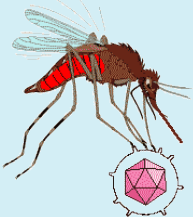

**Mosquito infection**  
Mosquito takes a blood meal from a person with acute dengue

**Extrinsic incubation**  
Virus infects the midgut and eventually travels to the salivary glands (usually 8–10 days)

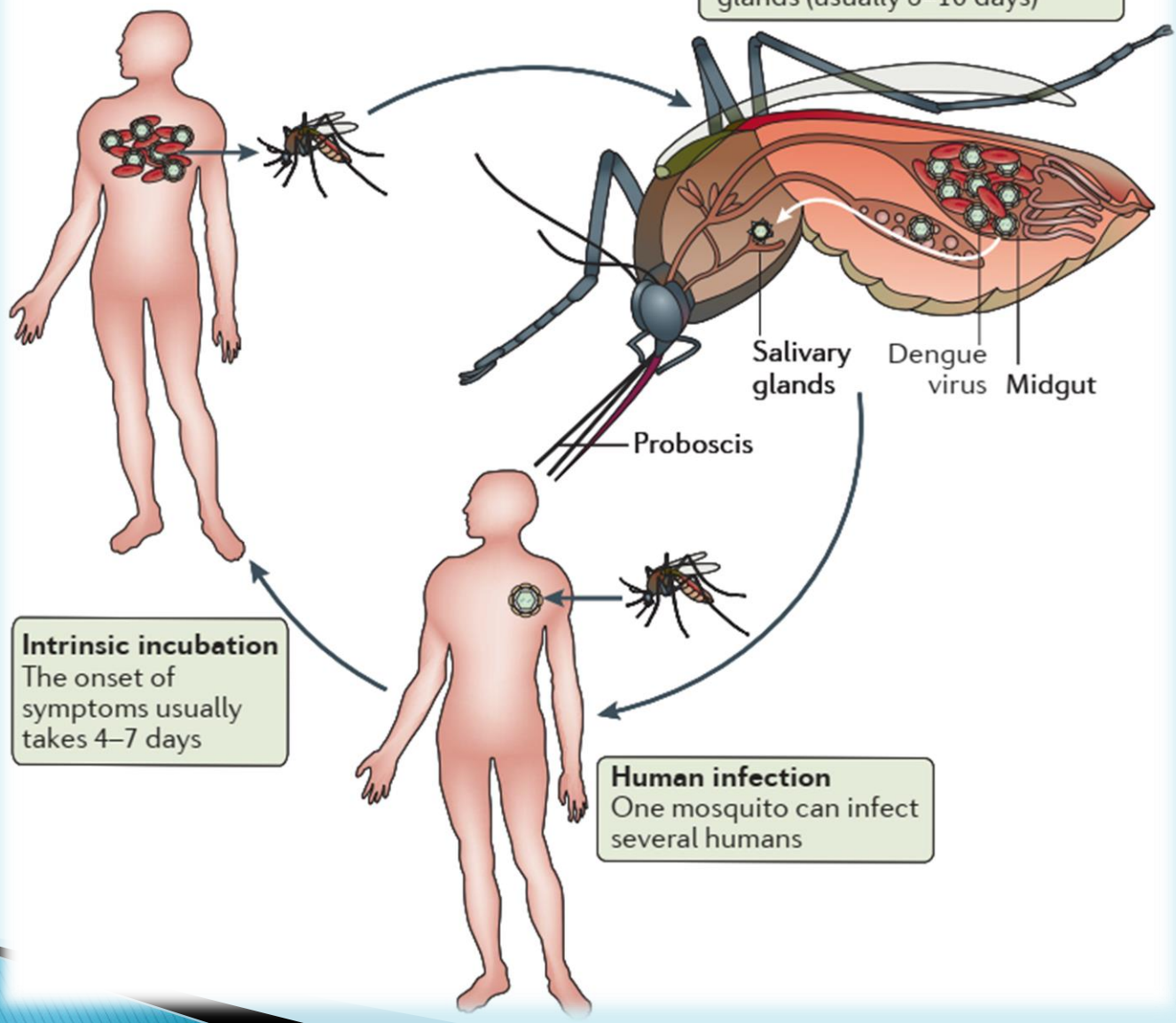

**Intrinsic incubation**  
The onset of symptoms usually takes 4–7 days

**Human infection**  
One mosquito can infect several humans

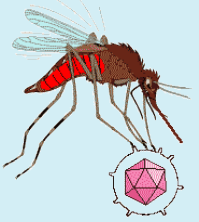

# morphological difference between *Ae. aegypti* and *Ae. albopictus*

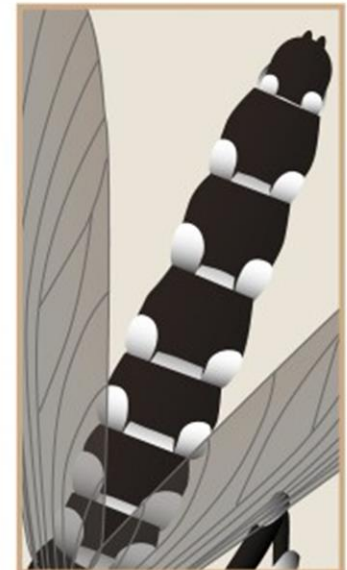
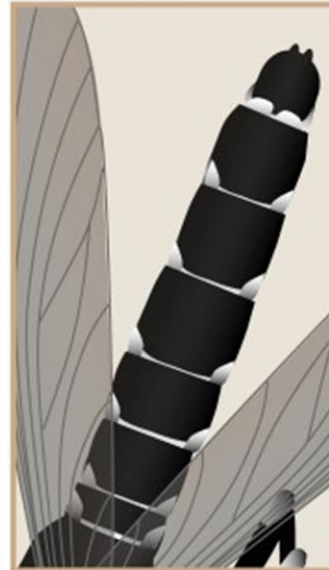
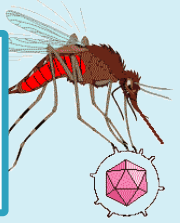

*Ae. albopictus*

*Ae. aegypti*

*Ae. albopictus*

*Ae. aegypti*

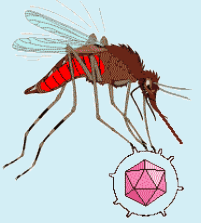

## *Global burden of disease*

- Recent best estimates of dengue disease burden suggest that over half of the world's population (**3.6 billion people**) live in areas that place them at risk of DENV infection,
  1. **390 million overall DENV infections,**
  2. **96 million symptomatic infections<sup>10</sup>,**
  3. **2 million cases of severe disease and**
  4. **21,000 deaths per year**

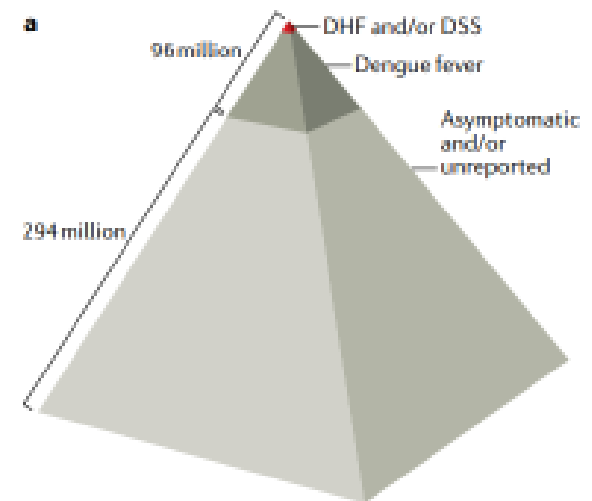

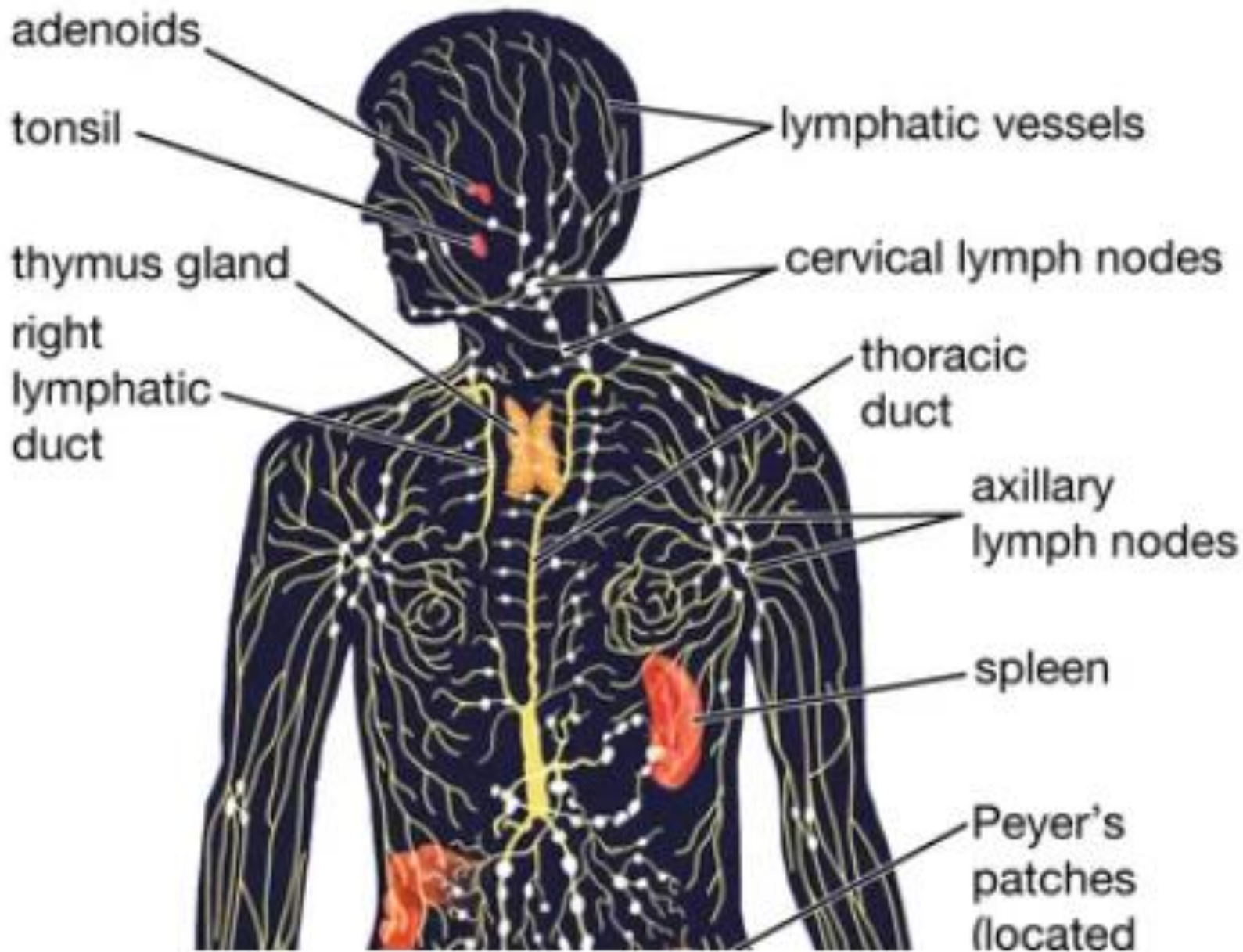
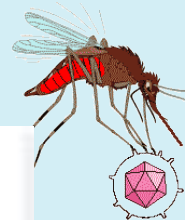

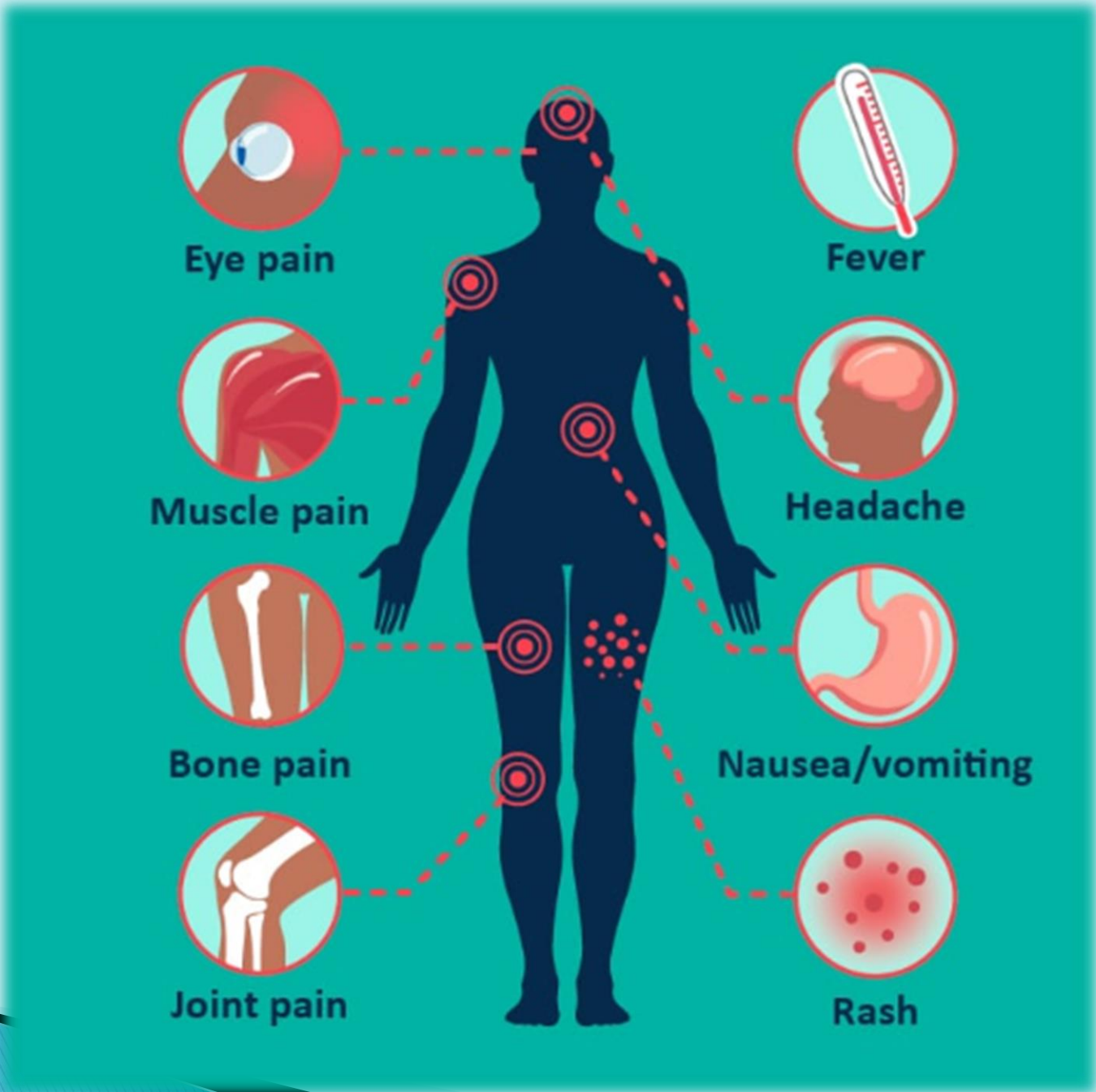
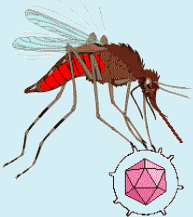

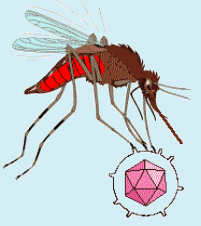

# Diagnosis

# Importance of Comprehensive Assessment

- ▶ Accurate diagnosis relies on integrating laboratory findings with:
  - **Patient history: especially travel to endemic areas**
  - **Clinical symptoms** (e.g. fever, headache, arthralgia, myalgia, rash, nausea, ....)
  - **Routine clinical laboratory.**



# Dengue Virus infection Kinetics

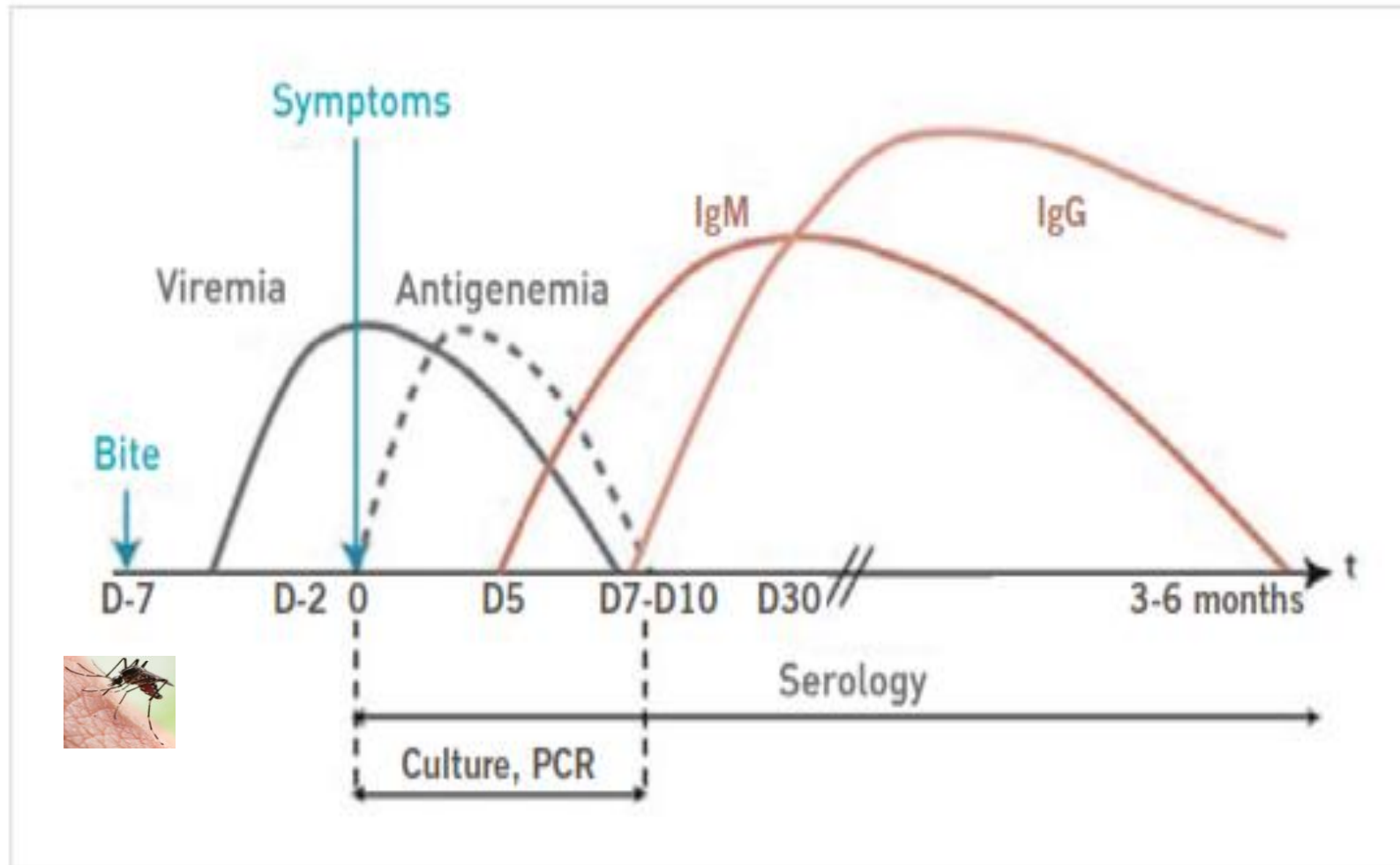
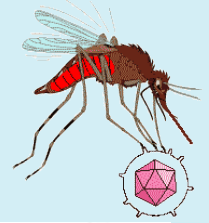

# Diagnostic methods

Direct methods

Indirect methods

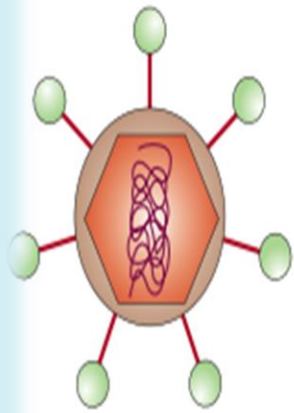

Virus  
isolation



Genome  
detection

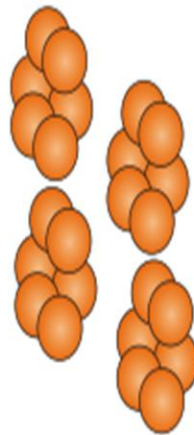

Antigen  
detection

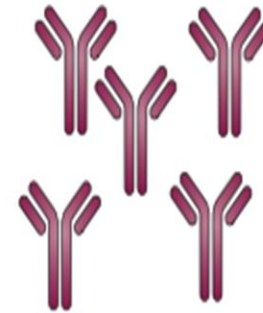

Serology  
IgM

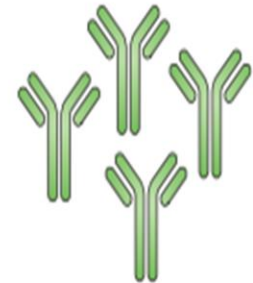

Serology  
IgG

Specificity

Opportunity

# Sampling strategy

Sample Type: **Serum**

**Two sets of samples** are required for each DENV suspected case:

**1: Acute phase sample (<7 days after onset of symptoms):**  
**Real Time PCR & ELISA (IgM + IgG)**

**2: Convalescent phase sample (2 weeks after acute sample):**  
**ELISA (IgM + IgG)**

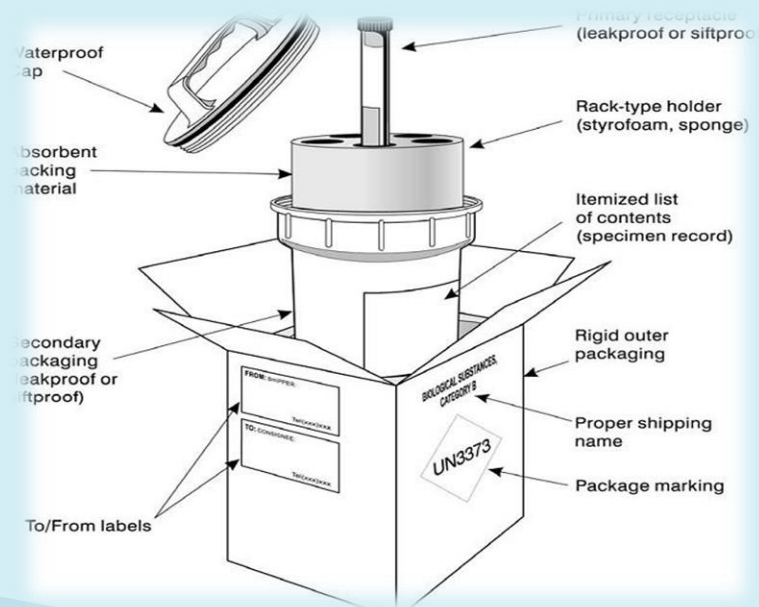

# Single Specimen

	Laboratory tests				Interpretation
	NS1	Real time RT-PCR #	IgM	IgG	
Single specimen	+	+	+	+	DENV Infection
	+	+	+	-	DENV Infection
	+	+	-	+	DENV Infection
	+	+	-	-	DENV Infection
	+	-	-	-	DENV Infection
	+	unknown	unknown	unknown	DENV Infection
	unknown	+	unknown	unknown	DENV Infection
	-	+	-	-	DENV Infection
	+	-	+	+	DENV Infection
	+	-	+	-	DENV Infection
	+	-	-	+	DENV Infection
	-	+	+	+	DENV Infection
	-	+	+	-	DENV Infection
	-	+	-	+	DENV Infection
	-	-	+	+	Presumptive DENV Infection*
	-	-	+	-	Presumptive DENV Infection*
	-	-	-	+	Presumptive DENV Infection*

Negative\*\*\*

# Paired Specimen

Laboratory tests					Interpretation
NS1	Real time RT-PCR #	IgM	IgG		
-	-	-	-	DENV Infection	
-	-	+	-	DENV Infection	
-	-	-	-	DENV Infection	
-	-	+	+	DENV Infection	
-	-	-	-	DENV Infection	
-	-	-	+	DENV Infection	
-	-	+	-	DENV Infection	
-	-	+	+	DENV Infection	
-	-	+	+	DENV Infection	
-	-	+	-	DENV infection	
-	-	+	+	DENV infection	
-	-	+	++**	DENV infection	
-	-	+	+	Presumptive Past DENV or other falaviviruses Infection	
-	-	+	+	Presumptive Past DENV or other falaviviruses Infection	
-	-	+	+	Presumptive Past DENV or other falaviviruses Infection	
-	-	-	+	Presumptive Past DENV or other falaviviruses Infection	
-	-	-	-	Negative	
-	-	-	-	Negative	
-	-	+	+	Inconclusive	
-	-	-/+	-	Inconclusive	
-	-	+	+	Negative****	
-	-	-	-	Negative****	

# Rapid Diagnosis Assay

## •Performance

### - Sensitivity :

- 92.4% (Dengue NS1 Ag),
- 94.2% (Dengue IgG/IgM)

### - Specificity :

- 98.4%(Dengue NS1 Ag),
- 96.4% (Dengue IgG/IgM)

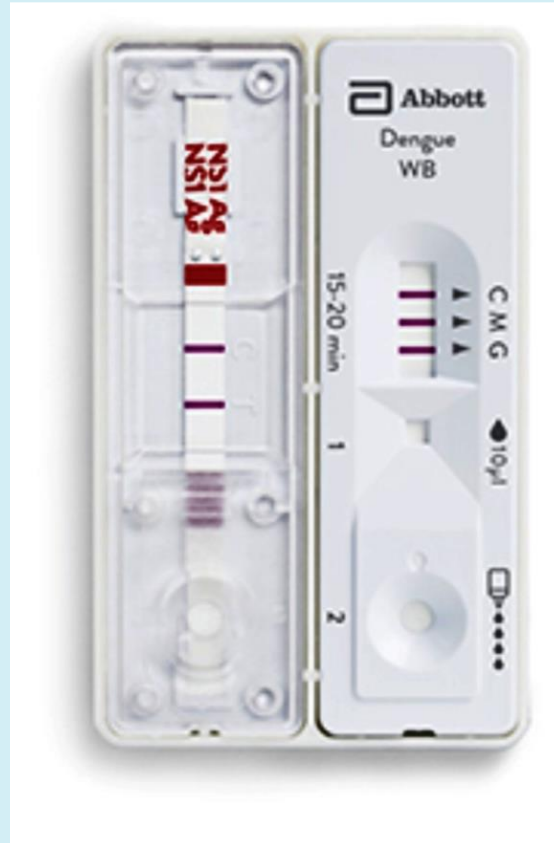

## NS1 Ag

3 drops (110  $\mu$ l) of plasma or serum  
for early acute phase samples (day 1 ~5)

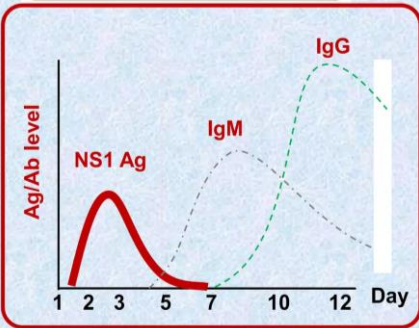
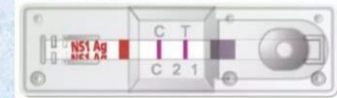

## IgG/IgM Ab

10  $\mu$ l of plasma or serum for early convalescence  
phase samples (after day 5 ~ 14)

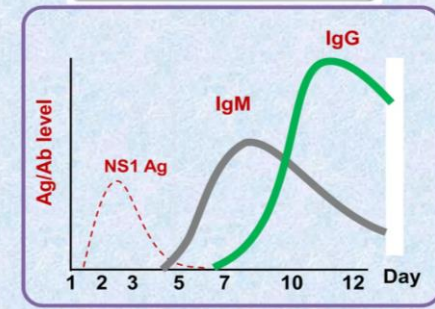

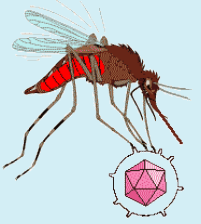

# Immunization

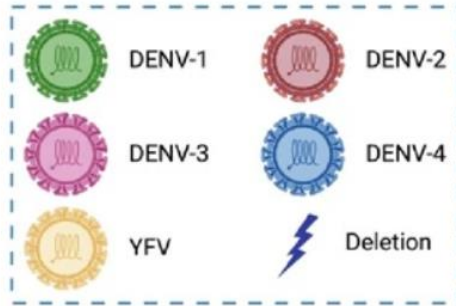

**Dengvaxia**

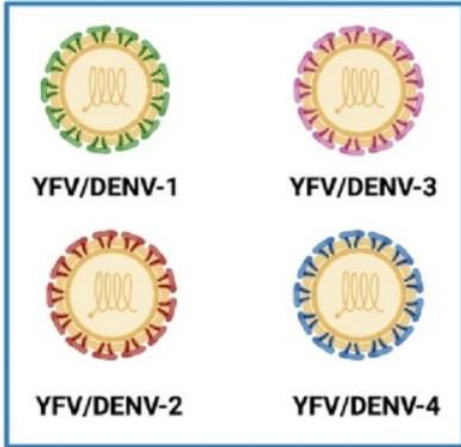



**TV003/TV005**

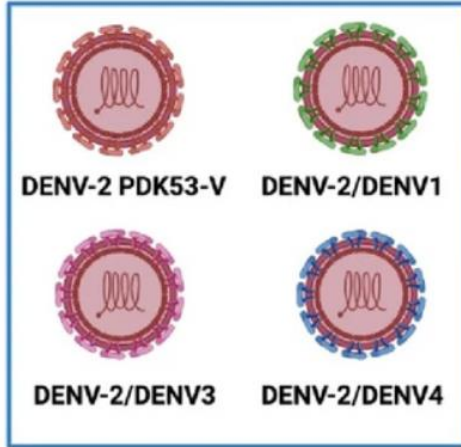

**Tak-003/DENVax**



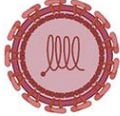

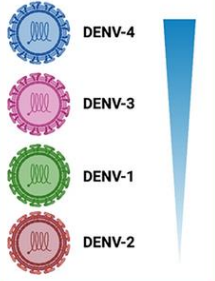
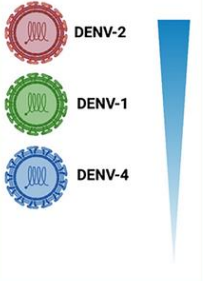
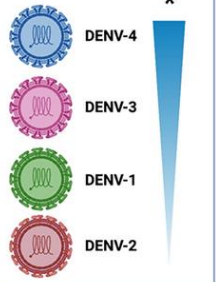
	Dengvaxia	DENVax	TV003/TV005
Backbone	 <p>Yellow Fever Virus (17D)</p>	 <p>Cell culture attenuated DENV</p>	 <p>DENVΔ30</p>
Serotype-specific efficacy			
Overall Efficacy (%)	**30.2% - 60.8%	62%	Data not available
Efficacy (%) seropositive	74.3-83.7 %	52.3%-83.4%	Data not available
Efficacy (%) seronegative	35.5%-43.2%	***43.5%-91.9%	Data not available



Thanks for your attention